

# **Loveland Water and Power: Algal Mitigation Assessment**

**Technical Memorandum**

**April 14, 2017**

**Prepared by Corona Environmental Consulting, LLC**

## Table of Contents

<b>EXECUTIVE SUMMARY</b> .....	<b>1</b>
ALTERNATIVES ANALYSIS.....	1
RECOMMENDATIONS .....	2
<i>Reservoir</i> .....	2
<i>WTP</i> .....	2
<i>Communications</i> .....	2
NEXT STEPS.....	3
<b>INTRODUCTION</b> .....	<b>4</b>
<b>TREATMENT PROCESS OVERVIEW</b> .....	<b>5</b>
GREEN RIDGE GLADE RESERVOIR .....	6
WATER TREATMENT PLANT PROCESS OVERVIEW .....	7
<b>HISTORICAL WATER QUALITY</b> .....	<b>8</b>
GEOSMIN.....	9
ALGAL CELL COUNTS.....	10
ALKALINITY.....	13
NITRATE, PHOSPHOROUS AND TOC.....	13
MANGANESE .....	14
STRATIFICATION .....	15
SAMPLING AND MONITORING CHALLENGES .....	16
<b>ALTERNATIVES ANALYSIS</b> .....	<b>17</b>
RESERVOIR ALTERNATIVES .....	18
<i>R1. Chemical Treatment</i> .....	18
<i>R1B. PAK27</i> .....	20
<i>R1C. Other Chemical Treatment Options</i> .....	20
PHYSICAL TREATMENT.....	22
<i>R2. Ultrasonic Treatment</i> .....	22
<i>R3. Reservoir Mixing</i> .....	24
<i>R4. Dissolved Oxygen Augmentation</i> .....	26
<i>R5. Emerging Technology for Phosphorus Removal (Biochar Now)</i> .....	28
WTP ALTERNATIVES .....	28
<i>W1. Exercising Various Gates within the Intake Tower</i> .....	28
<i>W2. Pre-oxidation (Chlorine Dioxide)</i> .....	30
<i>W3. Powdered Activated Carbon (PAC)</i> .....	30
<i>W4. Granular Activated Carbon (GAC) Filter Caps</i> .....	30
<i>W5. Advanced Oxidation Processes (AOP)</i> .....	31
<b>ALTERNATIVES SELECTION DECISION MATRIX</b> .....	<b>31</b>
SUMMARY OF ALTERNATIVE ANALYSIS .....	31
<b>RECOMMENDATIONS</b> .....	<b>34</b>
RESERVOIR .....	34
WTP.....	35
COMMUNICATIONS.....	35
<b>NEXT STEPS</b> .....	<b>35</b>

**APPENDIX A –VENDOR PROPOSALS.....37**

**LIST OF FIGURES**

Figure 1 Average monthly production from the Big Thompson River and the Green Ridge Glade Reservoir ..... 5

Figure 2 Aerial photo of the Green Ridge Glade Reservoir ..... 7

Figure 3 Routine sampling locations in the Green Ridge Glade Reservoir ..... 9

Figure 4 Geosmin concentrations at the surface and bottom of the Reservoir between 2013 and 2016 ..... 10

Figure 5 Total algae and Anabaena cell counts at surface and bottom of the Reservoir between 2011 and 2016..... 12

Figure 6 Seasonal manganese and Geosmin concentrations at the surface and bottom of the Reservoir ..... 15

Figure 7 Dissolved oxygen profile in the Reservoir in January, April, July, and October of 2015 16

Figure 8 Algal response from copper sulfate application in July 2012 ..... 19

Figure 9 Algal response from PAK27 in June and July 2016 ..... 20

Figure 10 Proposed locations for MPC Buoy and MPC Buoy Lite in the Green Ridge Glade Reservoir ..... 23

Figure 11 Proposed installation locations for Medora's SolarBee technology..... 25

Figure 12 Proposed installation location for the Eco2 Speece Cone at the Green Ridge Glade Reservoir ..... 26

Figure 13 Gates along the WTP intake tower in the Green Ridge Glade Reservoir..... 29

**List of Tables**

Table 1 Algal species and T&O causing metabolites observed in the Reservoir ..... 11

Table 2 Summary water quality data from June 2010 to December 2016 for the Reservoir intake monitoring location and the River intake..... 13

Table 3 Benefits and drawbacks of the LG Sonic ultrasound technology..... 23

Table 4 Installed capital cost for the LG Sonic MPC Buoy technology..... 24

Table 5 Benefits and drawbacks of mixing with Medora SolarBee technology ..... 25

Table 6 Medora SolarBee cost outcomes for 9.8 MGD withdraw rates from the reservoir ..... 26

---

Table 7 Design details for the Eco2 Speece Cone.....	27
Table 8 Benefits and Drawbacks for the Eco2 Speece Cone .....	27
Table 9 Eco2 Speece Cone capital costs .....	28
Table 10 Liquid oxygen supply costs for the Eco2 Speece Cone .....	28
Table 11 Design and cost details for filter cap installation.....	31
Table 12 Comparative summary for the Reservoir chemical treatment options evaluated .....	32
Table 13 Comparative summary for the physical installations in the reservoir .....	32
Table 14 Comparative summary of the WTP alternatives.....	33

## Executive Summary

Loveland Water and Power (LWP) uses two surface water sources for the production of drinking water – the Green Ridge Glade Reservoir (Reservoir) and the Big Thompson River (River). Colorado River water is fed to the GRGR via the Charles Hansen Feeder Canal. Since the 2013 flood events, LWP has experienced more severe seasonal algae blooms in the Reservoir and consequent water quality issues including discolored, musty water for extended periods of time. The taste and odor (T&O) issues in the Reservoir have progressively worsened and the highest concentrations of T&O causing compound, Geosmin, was observed in 2016.

In addition to T&O causing compounds, there are other water quality challenges in the Reservoir including seasonal release of manganese from sediments, stratification and depletion of dissolved oxygen from the hypolimnion, and increasing phosphorus loading to the Reservoir water. Historically, LWP had utilized two different chemical treatments (copper sulfate and sodium carbonate peroxyhydrate (PAK27)) to manage T&O events in the Reservoir with limited success. Currently LWP uses press releases and outreach on social media to address customer concerns. However, in the long term, future T&O events need to be limited by developing a multiple barrier approach to mitigate algal blooms and reducing the level of T&O causing compounds entering the distribution system.

In October 2016, LWP contracted Corona Environmental Consulting, LLC. (Corona) to perform a feasibility study to investigate management of algal blooms and T&O causing compounds in the Reservoir and at the water treatment plant (WTP). The specific objectives of the algal mitigation study were to:

- Review historical water quality and operational data and identify the causes and extent of the T&O challenges
- Evaluate control strategies for T&O reduction with the Reservoir
- Evaluate control strategies for T&O reduction within the water treatment plant (WTP)

The algal mitigation study consisted of review of historical water quality and water treatment operations, evaluation of multiple strategies for algae and T&O compounds control, and development of recommendations for full-scale implementation. This technical memorandum (memo) summarizes the outcomes of this evaluation, and outlines the multiple barrier approach that will be necessary for algae and T&O mitigation, including: (1) chemical treatment in the Reservoir; (2) physical treatment in the Reservoir to prevent algal growth, and (3) physical or chemical treatment approach within the water treatment facility.

## Alternatives Analysis

The feasibility analysis included consideration of both Reservoir and WTP algal mitigation alternatives, which are listed below:

- Reservoir Alternatives
  - Chemical Treatment
    - Copper sulfate
    - PAK27

- Other algae control chemicals (alum, nutrient control, etc.)
- Physical Treatment
  - Ultrasonic treatment
  - Mixing
  - Dissolved oxygen augmentation
  - Emerging technology for phosphorus removal
- WTP Alternatives
  - Exercising various gates within the intake tower
  - Pre-oxidation
  - Powdered Activated Carbon (PAC)
  - Granular Activated Carbon (GAC) filter caps
  - Advanced Oxidation Processes

Each of the alternatives were evaluated in detail as part of this project. This memo includes description of the technology, method of algal control, benefits, and drawbacks. Where applicable, equipment suppliers were solicited for design and cost proposals to facilitate comparison of the technologies.

### Recommendations

Based on review of water quality and operations data, and evaluation of treatment alternatives, the following are recommended for algae and T&O control at the LWP Reservoir and WTP. While outside the scope of this project, an effective communications plan is key to addressing T&O events, and as such recommendations for implementation of a communications plan are included:

#### Reservoir

- **Continue T&O monitoring program** in the Reservoir and source waters year-round, with increased frequencies during algal presence in the Reservoir.
- **Select a more effective chemical for algae treatment** than those previously used (copper sulfate and PAK27).
- **Install ultrasonic treatment equipment** supplied by LG Sonic in the Reservoir.

#### WTP

- **Exercise various gates within the WTP intake tower** throughout the year to withdraw the best quality water from the Reservoir. The WTP intake tower has six gates.
- **Determine the most appropriate PAC treatment strategy** for T&O control within the WTP.

#### Communications

- **Develop plans and templates for both internal and external communications** prior to, during and after T&O events
- **Include details within the communications** to explain cause(s) of the T&O issue, whether the water is still safe to drink or use, and actions taken by LWP to address the issue. Provide clear guidance on steps that can be taken by customers to mitigate T&O in their premises

- **Tailor communications for different audiences**, e.g. customers, board members, regulatory agencies, etc.

#### Next Steps

In order to implement the recommendations for algal and T&O mitigation as outlined above, the following next steps are suggested. Corona can assist LWP with all of these items, as needed:

- **Select appropriate supplier and chemical for Reservoir chemical treatment.** Additionally, LWP should establish a service contract with the chemical supplier, whereby the supplier is responsible for obtaining permits, applying chemicals, and monitoring water quality before and after chemical application
- **Implement LG Sonic ultrasonic treatment equipment within the Reservoir.** Prior to implementing this technology, additional equipment design details, ancillary equipment, operational considerations, and maintenance program details will need to be developed
- **Develop an optimal PAC treatment strategy for T&O control within the WTP.** This includes determination of PAC type, dose, contact time, as well as the WTP improvements necessary to facilitate additional storage and feed requirements.

## Introduction

Loveland Water and Power (LWP) uses two surface water sources for the production of drinking water – the Green Ridge Glade Reservoir (Reservoir) and the Big Thompson River (River). Colorado River water is fed to the Reservoir via the Charles Hansen Feeder Canal. Since the 2013 flooding across Colorado’s Front Range, LWP has experienced more severe seasonal algae blooms in the Reservoir and consequent water quality issues including discolored, musty water for extended periods of time. The taste and odor (T&O) issues in the Reservoir have progressively worsened and the highest concentrations of T&O causing compound, Geosmin, was observed in 2016. While T&O causing compounds do not pose a health risk, numerous customer complaints were received during the late summer and early fall of 2016. LWP water quality analysts and operational staff were proactive in responding to the T&O issues by closely monitoring water quality at the water treatment plant, as well as at the homes and businesses throughout the distribution system, withdrawing water from deeper levels of the Reservoir, and blending Reservoir water with more water from the River.

In addition to T&O causing compounds, there are other water quality challenges in the Reservoir including seasonal release of manganese from sediments, stratification and depletion of dissolved oxygen from the hypolimnion, and increasing phosphorus loading to the Reservoir water. Until 2016, LWP had tested two different chemical treatments (copper sulfate and sodium carbonate peroxyhydrate (PAK27)) to the Reservoir with limited success. Currently LWP uses press releases and outreach on social media to address customer concerns. However, in the long term, future T&O events need to be limited by developing a multiple barrier approach to mitigate algal blooms and to reduce concentrations of T&O causing compounds entering into the distribution system.

Algal blooms do not consistently produce T&O, and conversely, T&O causing compounds may still be present in the water in the absence of an algal bloom. Typical odor threshold concentrations for the dominant T&O compounds, 2-methylisoborneol (MIB) and Geosmin, are 10 ng/L and 15 ng/L, respectively. A small fraction of people are highly sensitive to T&O compounds and can detect them at lower levels. Given that Geosmin is the primary T&O causing constituent in the Reservoir water, LWP has established an odor threshold for Geosmin leaving the water treatment plant (WTP) of 10 ng/L.

In October 2016, LWP contracted Corona Environmental Consulting, LLC. (Corona) to perform a feasibility study to investigate management of algal blooms and T&O causing compounds in the Reservoir and in the treated water at the WTP. The specific objectives of the algal mitigation study were to:

- Review historical water quality and operational data and identify the causes and extent of the T&O challenges
- Evaluate control strategies for T&O reduction with the Reservoir
- Evaluate control strategies for T&O reduction within the WTP

The algal mitigation study consisted of review of historical water quality, source water management, water treatment operations, evaluation of multiple strategies for algae and T&O



control, and development of recommendations for full-scale implementation. This technical memorandum (memo) summarizes the outcomes of this evaluation, and outlines the recommended multiple barrier approach for algae and T&O mitigation, including: (1) chemical treatment in the Reservoir; (2) physical treatment in the Reservoir to prevent algal growth, and (3) physical or chemical treatment approach within the water treatment facility.

### Treatment Process Overview

As noted previously, LWP has two water sources that feed their treatment facility. Typically, the Reservoir is used year round and the River is used to the maximum of its allocation. LWP has senior water rights on the River and must use their allocation each year or lose a portion of their allocated supply. However, in recent years, LWP has been limited in what they can withdraw from the River due to: stabilizing in wake of the 2013 flood (2014), a pollutant spill in the River resulting in fish kill (2015), and extensive construction above the intake location (2016). Figure 1 shows the daily average production by month from each source from 2013 to 2016. The average daily production ranges between 20 and 25 MGD during the summer months, and between 6 and 8 MGD during winter months.

Figure 1 Average monthly production from the Big Thompson River and the Green Ridge Glade Reservoir

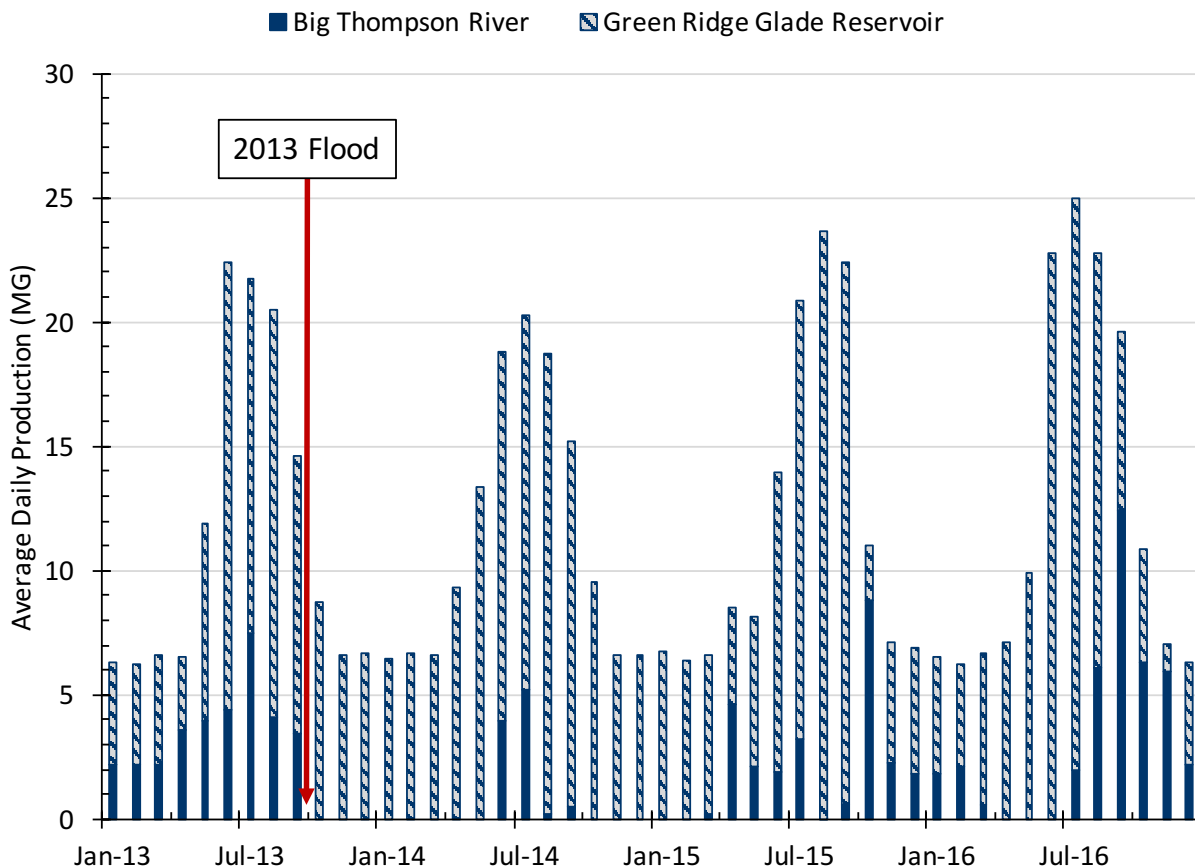

Due to high turbidity following the 2013 flood event, the River source was not used for 9 months. When turbidity subsided, the River intake was again used in 2014 and 2015 to blend with

Reservoir water for water production. Historically, the River is used in the winter months, however, during the T&O events occurring in the Reservoir from September 2016 to October 2016, LWP relied on the River to provide more than 50% of the supply in an effort reduce the T&O concentrations through blending.

#### Green Ridge Glade Reservoir

Figure 2 shows an aerial photograph of the Green Ridge Glade Reservoir. The surface area of the Reservoir is approximately 180 acres, and the Reservoir capacity is approximately 6,800 acre-ft when full. The average depth of the Reservoir ranges from 35 to 45 feet with some locations having depths of 79 feet. The Hansen Feeder canal delivers water to the northern portion of the Reservoir. The LWP WTP intake tower is located in the southern portion of the Reservoir.

Operational nuances and costs associated with the preventative technology to be installed in the Reservoir will be driven primarily by the depth and residence time in the Reservoir. For example, if the residence time is short and mixing were to be installed, lower mixing energies and costs would be required because less reaction time is available. Conversely, if there were a low Reservoir flow and a longer residence time, higher mixing costs would be incurred to maintain an adequately mixed water profile.

Figure 2 Aerial photo of the Green Ridge Glade Reservoir



### Water Treatment Plant Process Overview

The treatment plant consists of the following unit processes:

- PAC addition
- Aluminum sulfate and chlorine dioxide with rapid mix
- Multi-stage flocculation with polymer addition (Stage 1)
- High-rate clarification
- Dual media filtration
- Chlorine disinfection and storage prior to distribution

The current treatment process is limited for T&O removal by its PAC storage and feed system. PAC is well known to remove T&O compounds and is implemented by many utilities as their primary treatment strategy for T&O related customer complaints. LWP's current PAC dosing system has a maximum capacity of 3,600 lbs. per day, corresponding to a dose of 17 mg/L, assuming the average service flow from July 2016 of 25 MGD. ***A higher PAC dose capacity may be necessary at the LWP WTP for effective control of T&O causing compounds.***

## Historical Water Quality

LWP routinely monitors water quality parameters in the source waters. Water quality data are collected at six locations within the Reservoir as illustrated in Figure 3. At each of these locations, depth sampling is performed at three depths:

- Surface (S) sample: collected at 1m (3.3 ft) below the water surface
- Middle (M) sample: collected at twice the Secchi depth, typically 8m (26.2 ft) below the water surface
- Bottom (B) sample: collected at 1m (3.3 ft) above the bottom of the Reservoir.

In addition to these depth samples from the six locations on the Reservoir, the following locations are monitored routinely:

- Sample line from River to the Laboratory
- Sample line from Reservoir to the Laboratory
- Grab samples from the Canal
- WTP effluent

Monitoring Site 4 shown on Figure 3 is located close to the WTP's intake tower and is assumed to be representative of the water quality entering the treatment facility. At a minimum, samples from each of the sampling locations listed above are collected every other week during Spring, Summer, and Fall, and once a month during Winter.

LWP has a substantial amount of historical water quality data. The entire historical water quality dataset between May 2011 and December 2016 was reviewed and analyzed as part of this study. This section provides a summary of the general water quality. The focus of this study were water quality parameters that contribute to T&O causing compounds, and as such, select water quality data relevant to T&O, and that influence the treatment technologies considered, are discussed in this section. If the future water quality is different than the historical data analyzed, the algal management strategy will need to adopt and reflect the changes.

Figure 3 Routine sampling locations in the Green Ridge Glade Reservoir

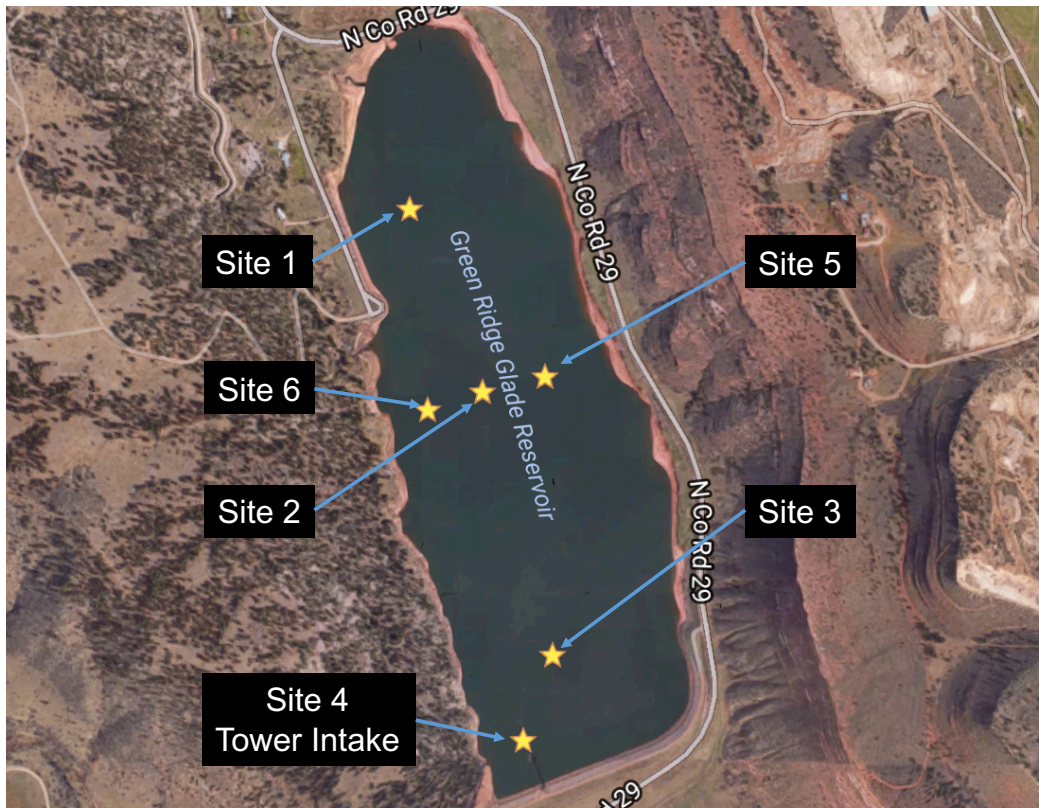

### Geosmin

Geosmin is the primary T&O causing compound in the Reservoir. Geosmin is a naturally occurring organic compound with a distinct earthy taste and aroma produced by bacteria in soil and algae found in surface water. Figure 4 shows the Geosmin concentrations at the surface and bottom of the Reservoir between 2013 and 2016. The highest Geosmin concentrations occur near the surface and peak concentrations have increased steadily from 292 ng/L in 2013 to 640 ng/L in 2015 to 1,400 ng/L in 2016. These concentrations are two orders of magnitude higher than the odor threshold of 10 ng/L. Typically, Geosmin concentrations in the bottom of the Reservoir are lower than at the surface. As such, during periods of high T&O, LWP can consider withdrawing water from the bottom of the Reservoir, which would likely have lower Geosmin concentrations. However, as can be seen from Figure 4, in 2016, Geosmin concentrations even at the bottom of the Reservoir peaked at 200 ng/L. MIB concentrations in the Reservoir were also reviewed for the period 2013 to 2016, and MIB concentrations are consistently lower than 10 ng/L at all depths of the Reservoir. As such, MIB is not a significant T&O contributor in the LWP water.

Figure 4 Geosmin concentrations at the surface and bottom of the Reservoir between 2013 and 2016

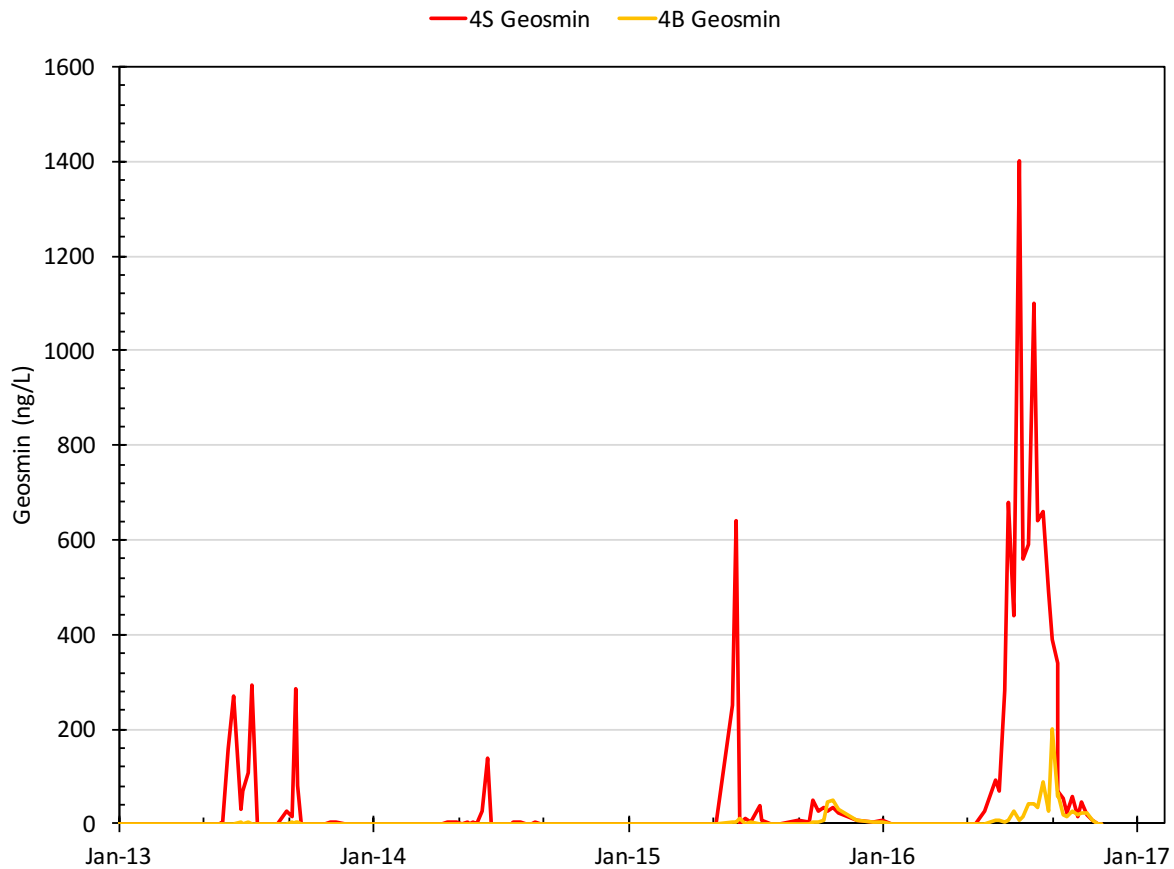

### Algal Cell Counts

Anabaena is the most frequently occurring cyanobacteria causing T&O in the Reservoir. Historically, LWP has detected three different species of Anabaena in the Reservoir. Other algae frequently detected in the Reservoir include Asterionella, Fragilaria, Mallomonas, Cyclotella, and Synedra. Oscillatoria was detected for the first time in 2016. Oscillatoria is of concern because it contributes to T&O and is a benthic organism making it more difficult to control. Table 1 summarizes the frequently detected algal species in the Reservoir, and the T&O causing metabolites they are known to produce.

Table 1 Algal species and T&O causing metabolites observed in the Reservoir

Algal Species	Class	T&O Causing Metabolite
Anabaena	Cyanobacterium	2-MIB, Geosmin
Asterionella	Diatom	2-MIB, Geosmin
Fragilaria	Diatom	-
Mallomonas	Ochrophyta	-
Cyclotella	Diatom	2-MIB, Geosmin
Synedra	Diatom	2-MIB
Oscillatoria	Cyanobacterium	2-MIB, Geosmin

Figure 5 shows the total algal cell counts (#/mL) as well as the Anabaena counts at the surface and bottom of sampling Site 4 in the Reservoir which is close to the WTP intake tower. LWP does not quantify individual algal species, but total algae cells and Anabaena cells are counted. As can be seen from the Figure, prior to 2016, the total algae cell counts at all depths were typically less than 10,000 cells/ mL, even though occasional spikes were observed. However, in 2016, there was a significant increase in algal cell counts at all depths in the Reservoir. The total algae cell counts on the surface of the Reservoir exceeded 60,000 cells/mL. The other key observation from Figure 5 is that T&O causing algae often make up more than 80 to 90 percent of the total algal population. This is very significant in the assessment and development of algal control strategies in the Reservoir.

Figure 5 Total algae and Anabaena cell counts at surface and bottom of the Reservoir between 2011 and 2016

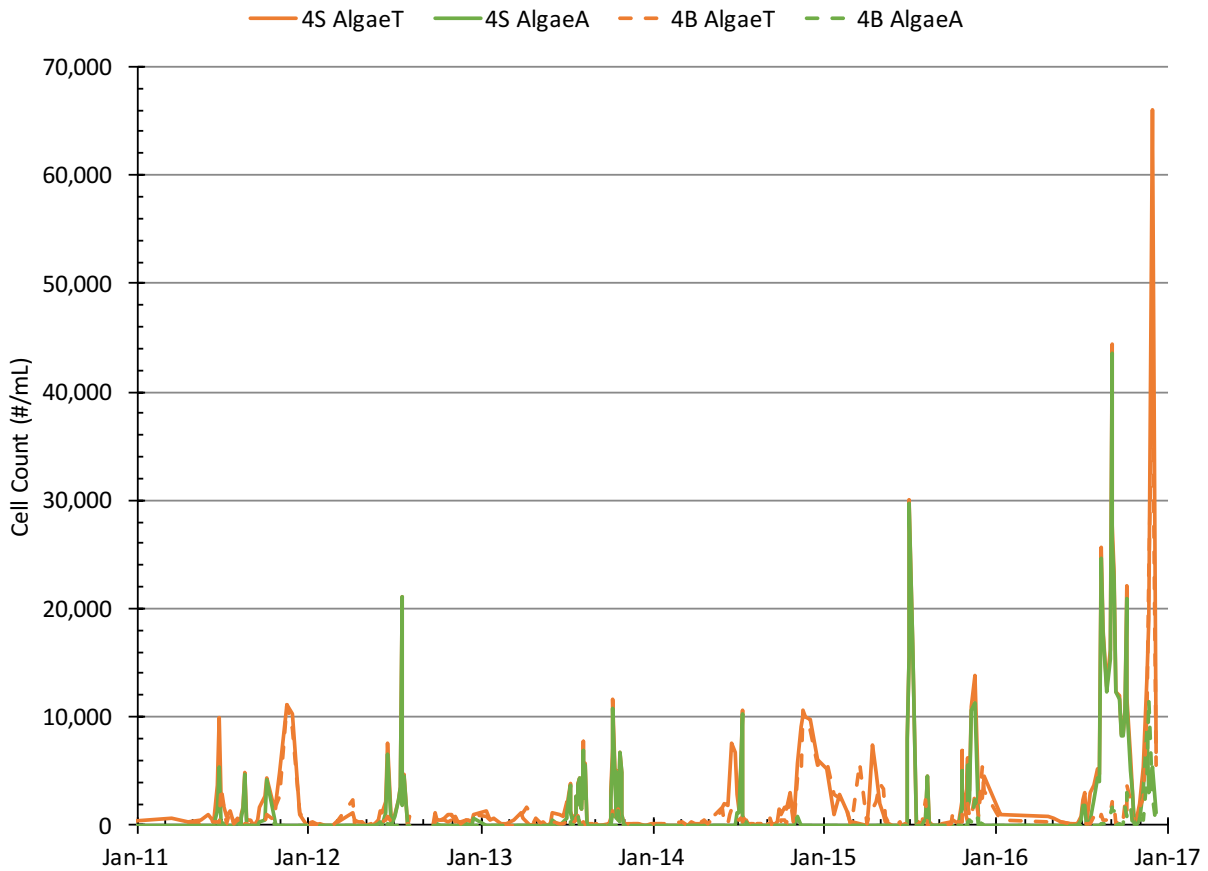

Table 2 shows summary water quality data, from June 2010 to December 2016 for the top and bottom of Site 4 and the River intake line. For each water quality parameter, the number of samples (count), minimum, 95<sup>th</sup> percentile, and maximum concentrations are shown. The 95<sup>th</sup> percentile is shown to eliminate the impact of outliers on the dataset.



Table 2 Summary water quality data from June 2010 to December 2016 for the Reservoir intake monitoring location and the River intake

Analyte	Site 4 Surface	Site 4 Bottom	River Intake	
Alkalinity (mg/L)	Average	24	27	22
	95 <sup>th</sup> percentile	30	34	36
	Min	16	18	6
	Max	35	38	44
	Count	120	119	97
Nitrate as N (mg/L)	Average	0.08	0.13	0.33
	95 <sup>th</sup> percentile	0.23	0.29	0.72
	Min	0	0	0
	Max	0.31	0.35	2.65
	Count	120	117	109
Orthophosphate as P (mg/L)	Average	0.01	0.04	0.10
	95 <sup>th</sup> percentile	0.05	0.14	0.29
	Min	0	0	0
	Max	0.34	0.36	0.52
	Count	106	105	81
TOC (mg/L)	Average	4.3	4.2	4.4
	95 <sup>th</sup> percentile	6.0	5.5	8.2
	Min	3.3	2.3	2.6
	Max	6.7	5.8	16.2
	Count	103	101	84
Manganese (mg/L)	Average	0.019	0.071	0.042
	95 <sup>th</sup> percentile	0.037	0.325	0.268
	Min	0.000	0.005	0.003
	Max	0.096	0.495	0.348
	Count	122	121	101

### Alkalinity

Alkalinity can impact the effectiveness of algal control treatment within LWP’s WTP. The proposed alternatives should not result in alkalinity changes in the reservoir, and if they do, treatment effectiveness may be impacted. The alkalinity concentrations are similar in all three locations.

### Nitrate, Phosphorous and TOC

Nitrogen, phosphorus, and total organic carbon (TOC) are the nutrients required for biological growth. One of the primary control strategies for mitigating algal activity is to limit available nutrients. Nitrate concentrations are not of very high concern in the two source waters. The 95<sup>th</sup> percentile nitrate concentrations are 0.29 and 0.72 mg/L (as N) in the Reservoir and the River

respectively. Orthophosphate as P concentrations in the Reservoir are relatively low on the surface, with a 95<sup>th</sup> percentile concentration of 0.04 mg/L and the maximum observed concentrations on the surface and on the reservoir bottom are above 0.20 mg/L. Typically, algae are phosphorus limited. When total phosphorus concentrations rise above 0.20 mg/L algae are more likely to proliferate. TOC reacts with the disinfectant chlorine to form regulated disinfection by-products (DBPs) which are divided into two classes, five haloacetic acids (HAA5) and total trihalomethanes (TTHM). TOC concentrations in the Reservoir are not of concern and LWP routinely achieves the TOC reduction regulatory requirement. LWP also have not had any challenges in complying with the locational running annual average (LRAA) MCL levels of TTHMs and HAA5s in the distribution system in recent years.

### Manganese

Manganese is regulated as a secondary contaminant that does not pose health impacts but does present aesthetic issues with discolored water, typically with a pink hue. Manganese is regulated with the secondary maximum contaminant level (SMCL) of 0.050 mg/L. Manganese is below the SMCL on the surface of the Reservoir with a 95<sup>th</sup> percentile concentration of 0.037 mg/L and above the SMCL on the bottom of the Reservoir with a 95<sup>th</sup> percentile of 0.325 mg/L. These elevated concentrations at the bottom of the Reservoir occur seasonally and are short lived. This phenomenon is likely due to reservoir turnover and particulate manganese release from deposited sediments. Figure 6 shows the seasonal variation of manganese concentrations and its temporal correlation with Geosmin occurrence. As seen in Figure 6, manganese peaks typically occur around end of September or October when the Reservoir turns over. In contrast, Geosmin peaks are observed between June and August. The manganese concentrations are also much higher at the bottom of the Reservoir, while the Geosmin concentrations are higher near the surface. As such, it may be possible to withdraw water from different depths of the Reservoir during these water quality events, and avoid the highest concentrations of these contaminants.

Figure 6 Seasonal manganese and Geosmin concentrations at the surface and bottom of the Reservoir

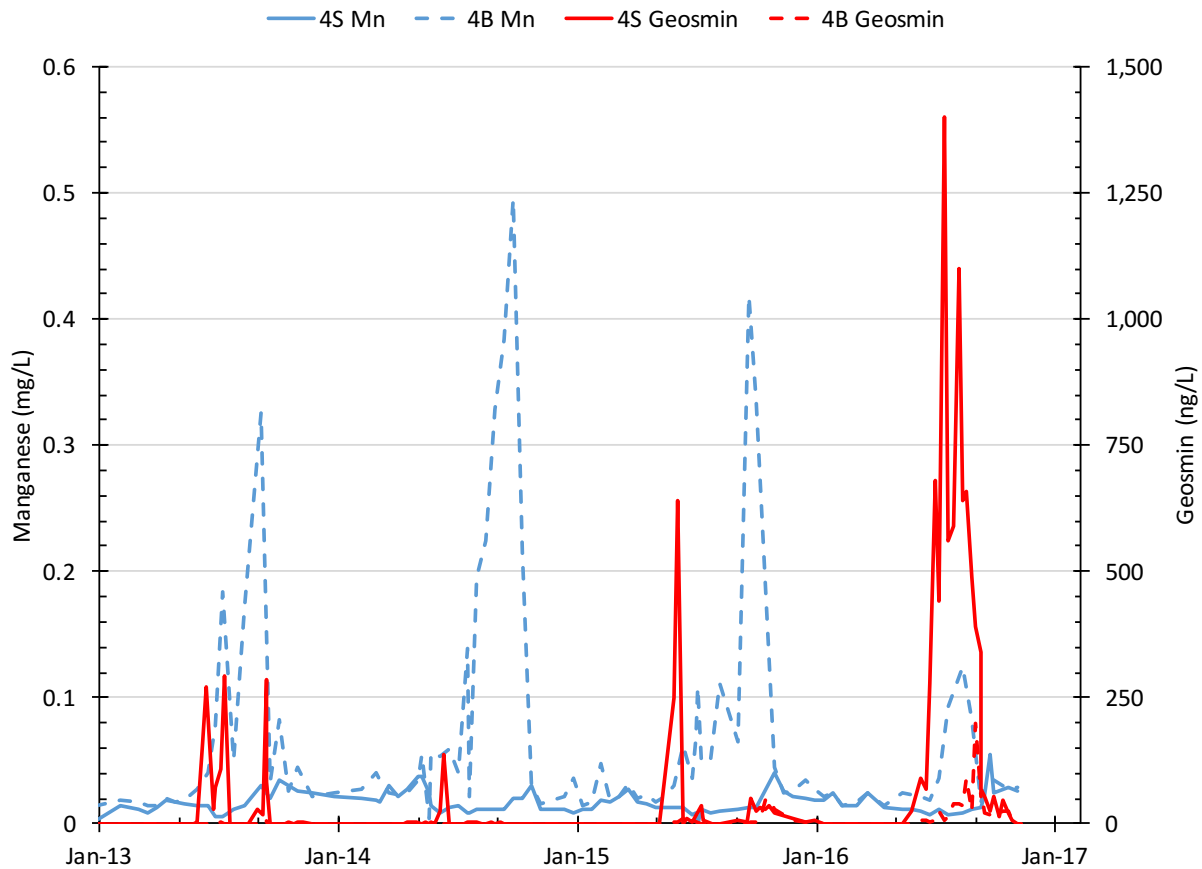

### Stratification

In addition to algal growth, T&O, and manganese, the Reservoir also stratifies during summer, and there is a turnover in late fall or early winter. Figure 7 shows the depth profile of dissolved oxygen in the reservoir in July and October of 2015. Reservoir stratification typically starts around May, and as can be seen from Figure 7, by July, the Reservoir is very well stratified below a depth of 20 ft. Dissolved oxygen concentrations are close to 8 mg/L at the surface of the Reservoir, but drops to approximately 4 mg/L at a depth of 40 ft, and are less than 3 mg/L at the bottom of the Reservoir. This stratification in October when dissolved oxygen concentrations below a depth of 50 ft are close to 0 mg/L.

Figure 7 Dissolved oxygen profile in the Reservoir in January, April, July, and October of 2015

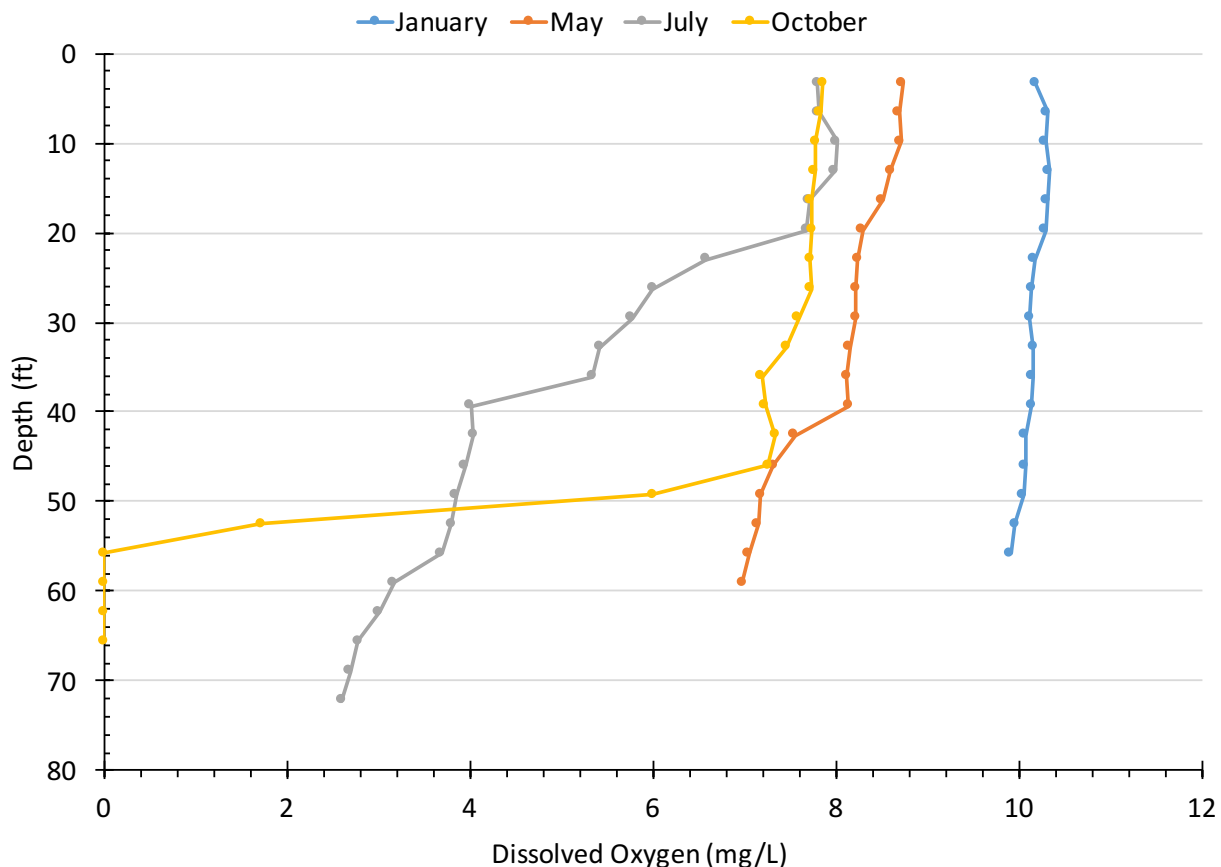

### Sampling and Monitoring Challenges

LWP maintains a source water T&O monitoring program. The program is aimed at assessing likelihood of occurrence of T&O events, providing information to inform operational changes at the WTP, and alerting customers when T&O events are being experienced. LWP’s current T&O monitoring plan includes analyses of MIB, Geosmin, dissolved oxygen, chlorophyll-a (depth analysis), algal count, nitrate, and phosphorus every-other-week throughout the year. When visual signs of algal bloom are observed in the Reservoir, typically in April, monitoring frequency is increased to weekly. During periods of an algae bloom, the sampling frequency is increased to every other day.

In the future, the collected T&O monitoring data should be catalogued in a database that can be used to predict water quality parameters during future T&O events. A T&O monitoring database will help illustrate if T&O events are recurring at the same time each year and if they can be predicted through the monitoring of surrogate water quality parameters. The T&O monitoring plan should be expanded to include phycocyanin. Phycocyanin is blue-green algae pigment and can be indicative of early growth phases of T&O producing bacteria.

## Alternatives Analysis

In recent years including 2016, warmer summer temperatures combined with high nutrient loads into the Reservoir caused a large seasonal algae bloom that resulted in T&O issues experienced by LWP customers. However, it should be noted that a large algal bloom does not necessarily cause T&O issues, and on the contrary, often small blooms can cause extremely high T&O concentrations. Also, T&O compounds do not pose health impacts and are not regulated, but create a negative perception among customers about water quality. T&O thresholds for different individuals vary widely, and some sensitive individuals may be able to detect T&O causing compounds in water at very low levels. All of these considerations need to factor into the assessment and development of algal mitigation and management strategies.

Based on the above factors, one technology may be optimal in one location while a completely different strategy could be viable elsewhere. Additionally, any physical or chemical algal control strategy will have their own benefits and drawbacks. For example, some strategies may result in formation of unacceptable residuals or byproducts, while other strategies have high capital costs, or may require a high level of attention or be onerous to operate. ***A comprehensive analysis of algae mitigation alternatives requires consideration of both benefits and drawbacks of each management strategy.***

The review of the historical water quality data, described above, indicates that there is a significant potential for algal growth and consequent generation of T&O in LWP's source waters. Knowing that there is typically not a singular solution for T&O control, a comprehensive, multiple barrier approach will be necessary to achieve the desired T&O targets in the treated water. This feasibility analyses included consideration of both Reservoir and WTP algal mitigation alternatives, which are listed below:

- Reservoir Alternatives
  - Chemical Treatment
    - Copper sulfate
    - PAK27
    - Alum or other nutrient control chemicals
  - Physical Treatment
    - Ultrasonic treatment
    - Mixing
    - Dissolved oxygen augmentation
    - Emerging technology for phosphorus removal
- WTP Alternatives
  - Exercising various gates within the intake tower
  - Pre-oxidation
  - Powdered Activated Carbon (PAC)
  - Granular Activated Carbon (GAC) filter caps
  - Advanced Oxidation Processes

Each of the above alternatives are described in this section, including a technology description, method of algal control, benefits, and drawbacks. Where applicable, the equipment suppliers were solicited for design and cost proposals to facilitate comparison of the technologies. The original proposals received from the equipment suppliers are included in Appendix A – Proposals from Vendors.

## Reservoir Alternatives

### R1. Chemical Treatment

Historically, chemical treatment has been the only algal mitigation strategy used by LWP in the Reservoir. LWP has tested both copper sulfate and PAK-27 for algal control in the Reservoir. In addition to these two, there are other algal control chemicals available, including chemical oxidants, nutrient control chemicals, etc.

#### *R1A. Copper Sulfate*

LWP effectively used copper sulfate ( $\text{CuSO}_4$ ), from Chem One Ltd., in the Reservoir until 2015. Copper sulfate has been commonly used as an algaecide, despite risks such as the lysing of algal cells resulting in the Geosmin and increase in dissolved copper concentrations. Figure 8 shows the copper application response in the Reservoir from June 26, 2012 to July 31, 2012, where AlgaeT represents the total algae count.

On July 9<sup>th</sup>, LWP applied copper sulfate in the Hansen Feeder Canal with nominal impact for surface algae, but there was a noticeable decrease algal communities at the middle depth. Sampling was less frequent at the bottom depths due to the consistently low algal counts observed. On July 13<sup>th</sup> and July 20<sup>th</sup>, copper sulfate was applied on the Reservoir surface resulting in immediate algal death and overall reduction in total algal count. Other chemical application dates were evaluated in a similar fashion and all copper sulfate application dates show a decrease similar to that shown in Figure 8.

Figure 8 Algal response from copper sulfate application in July 2012

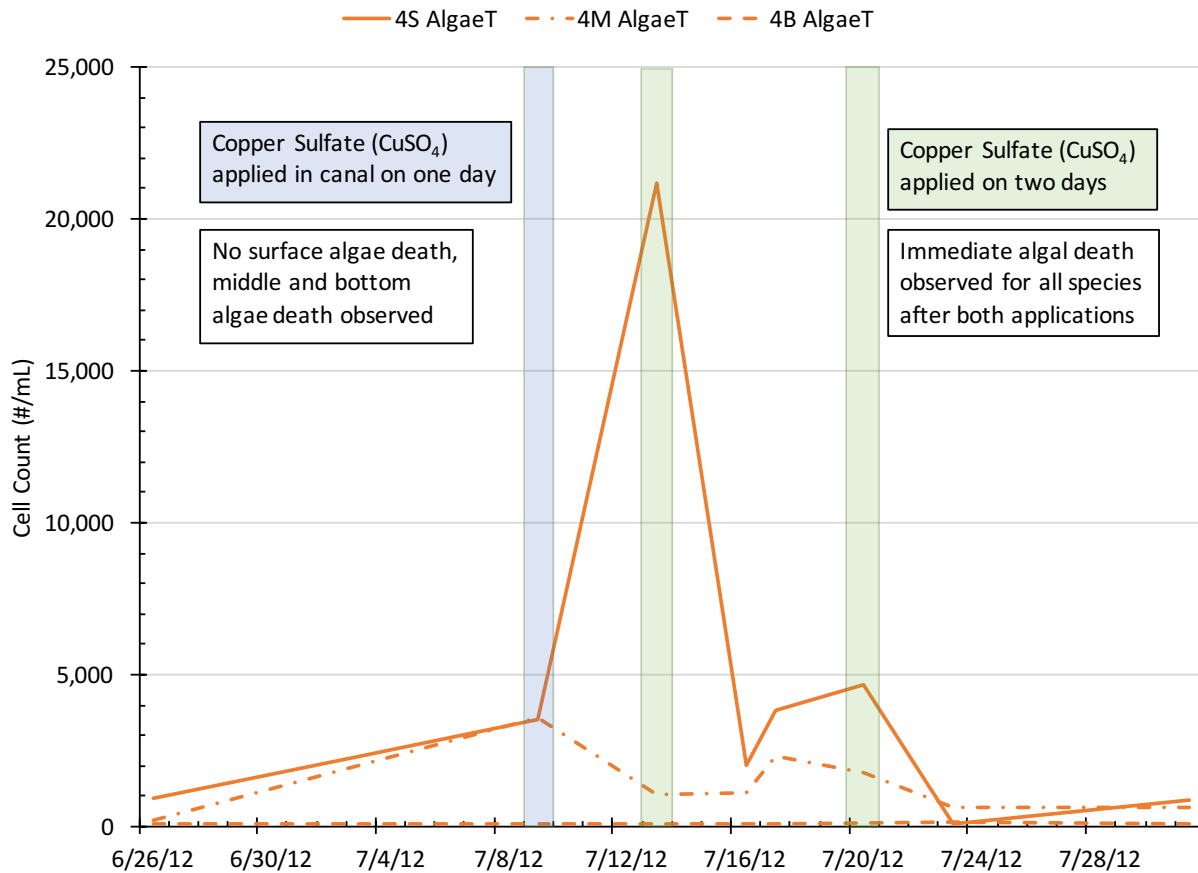

LWP opted to discontinue the use of copper sulfate due to the risk of violating the Colorado Discharge Permit System (CDPS) permit issued by the Colorado Department of Public Health and Environment (CDPHE). The section of the Big Thompson River surrounding LWP’s intake is included on the 303(d) list for impaired river supplies in the Western United States for copper contamination. On February 3, 2016, the copper discharge levels for this section of the Big Thompson River were revised to not exceed 11 µg/L for a single day or 7.5 µg/L as a 30-day average, limiting LWP’s ability to apply copper sulfate in the Reservoir. Although copper sulfate is no longer being used, elevated copper concentrations are still observed in the discharge.

**Recent discussions with CDPHE indicated that it is possible for LWP to seek a Discharge Variance Permit, by citing financial, water quality, or treatment process challenges resulting from compliance with the CDPS permit.** CDPHE did however note that seeking a variance is a lengthy process and there is no guarantee of success. With this in mind, alternate chemical application strategies or products for algal mitigation should be explored.

R1B. PAK27

PAK27 Algaecide is manufactured by SePRO Corporation as a sodium carbonate peroxyhydrate based oxidant for algae control. LWP converted to PAK27 after discontinuing the use of copper sulfate.

Figure 9 shows the algal response from PAK27 application in June and July 2016. It is difficult to discern if the first application date shown (June 30<sup>th</sup>) resulted in reduced algal counts. The second date shown on July 15<sup>th</sup> did not reduce the algal population. The third application, on July 25<sup>th</sup>, had marginal effect at the surface and algal counts increased at the middle depth. Algal counts were relatively low at the bottom depth during each application.

Figure 9 Algal response from PAK27 in June and July 2016

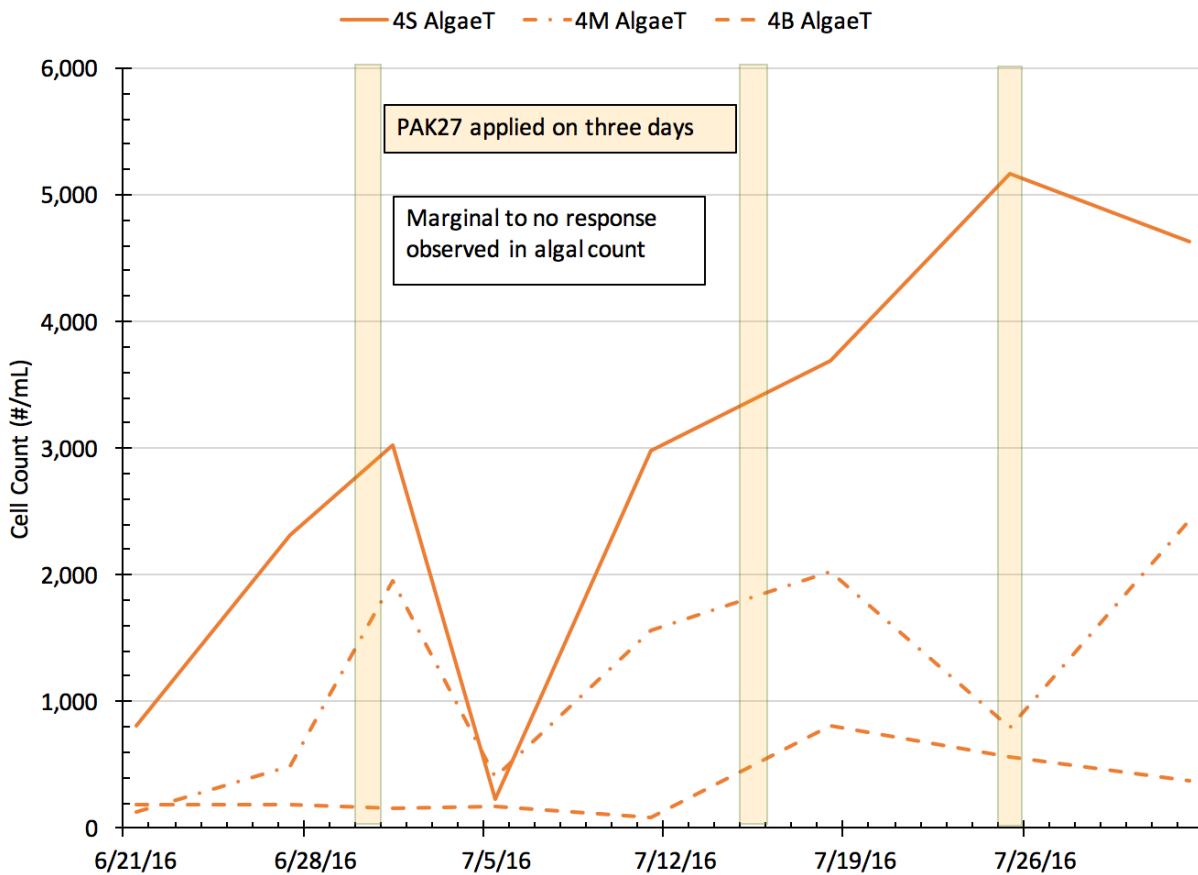

Copper sulfate appears to be more appropriate and effective for algal mitigation in the Reservoir when compared to PAK27. Given the ineffectiveness of PAK27, alternative chemical treatment options are described below.

R1C. Other Chemical Treatment Options

Numerous other chemical treatment options and chemical suppliers are available for algal control. As part of this project, LWP has made contact with two chemical suppliers, Lonza and



SOLitude Lake Management. Both of these chemical suppliers offer a number of algae control products for surface reservoir applications, in both crystalline and liquid form. The products can be copper based, peroxide or other oxidant based, or nutrient control chemicals. All of the products discussed below are approved for use in source waters intended for drinking water production.

Some of the proprietary chemicals supplied by Lonza include:

- Algimycin
- Phycomycin
- Cutrine-Plus (liquid)
- Cutrine-Plus (granular)

The SOLitude supplied chemicals include:

- Phoslock
- GreenClean Liquid 5.0
- Alum

Several of these products have the potential to be effective in controlling algal growth in the Reservoir. While some of these products will be more effective in reducing live algal blooms (e.g. copper or peroxide based algaecides), others may be more beneficial in the long term because they reduce phosphorus which is a necessary nutrient for algal growth (e.g. alum based chemicals). A combination of two different chemicals, applied at different times and different frequencies may provide further benefits. While additional details and supporting information on each of the products listed above are not included in this report, technical specifications and other details were obtained on these products as part of this project, and shared with LWP staff.

However, these products need to be tested first, when there is algal growth in the Reservoir, prior to selection. Also, the appropriate doses and application methods need to be determined. In addition to surface application, depth application with trailing hoses from the boat spreader should also be considered. Lonza and SOLitude each offer service contracts. The service contracts include permitting support, third party application, and water quality monitoring.

***Given the copper discharge limits and the limited effectiveness observed with PAK27, it is recommended that LWP proceed with evaluating of an alternate chemical from either Lonza, SOLitude or similar chemical or service provider.*** Additionally, it is recommended that LWP also consider establishing a service contract with the chemical supplier, whereby they will be responsible for determining the appropriate chemical and dose, and applying it in the Reservoir at necessary frequencies. The following are the critical next steps related to chemical treatment in the Reservoir:

- Engage chemical supplier(s) to determine the appropriate chemical, recommended doses, frequency, and costs for chemical application. In order to do this, limited testing may be necessary with water when algal growth is observed in the Reservoir. Lonza, for example, has developed a standardized “Algal Challenge Test” that can be performed using water from the Reservoir at bench-scale.

- Once the recommendations are received from the supplier, LWP perform in-house testing with the selected chemical in order to determine effects on other water quality. Any effects of the chemical on other non-target species (vertebrates, invertebrates, etc.) need also be determined
- LWP should execute a service contract with the chemical supplier outlining the roles and responsibilities of each party, along with costs. Due to year to year variability in algae growth, the service contract should be flexible in terms of the fixed number of applications, as well as “as-needed” applications
- The supplier contracting and chemical selection process should be completed prior to Summer 2017 such that when algal blooms are experienced in the Reservoir, the response strategy is already in place.

## Physical Treatment

### R2. Ultrasonic Treatment

#### *Description of Technology*

Ultrasonic approaches control algae by emitting ultrasonic waves that impact the buoyancy of the algae, preventing them from rising to the surface which limits photosynthesis. Without photosynthesis, algae cells do not proliferate and effectively die off. While multiple suppliers provide ultrasonic equipment, the evaluation herein focuses on the LG Sonic MPC and MPC Buoy Lite equipment as a result of our project team’s experience and familiarity with the product.

For the Reservoir, LG Sonic proposed two pairs of MPC Buoy and MPC Buoy Lite equipment. Figure 10 shows the proposed installation locations. The LG Sonic equipment relies on tuning of ultrasonic frequencies based on real time water quality results for reliable algal mitigation. Both the MPC Buoy and the MPC Buoy Lite are solar powered ultrasonic wave emitters. The MPC Buoy is equipped with water quality monitoring, specifically chlorophyll-a, phycocyanin, and dissolved oxygen and data are uploaded continuously to LG Sonic servers, to inform the appropriate treatment frequency. The data from the MPC Buoy is then used to control the corresponding MPC Buoy Lite

LG Sonic anticipates that the proposed installation would provide 60-90% algal bloom reduction. The effectiveness may increase over time as more water quality information is gathered and the buoys are effectively tuned. LG Sonic utilizes a specific frequency to target inhibition of the dominant algae present. Eliminating algae from the photic zone can promote growth of benthic algae living lower in the reservoir. However, because the frequency is targeted to a specific algae type, once one algae species has been managed, the frequency could be changed to target another. The real time water quality monitoring that the LG Sonic technology utilizes informs how the frequency should be changed.

Figure 10 Proposed locations for MPC Buoy and MPC Buoy Lite in the Green Ridge Glade Reservoir

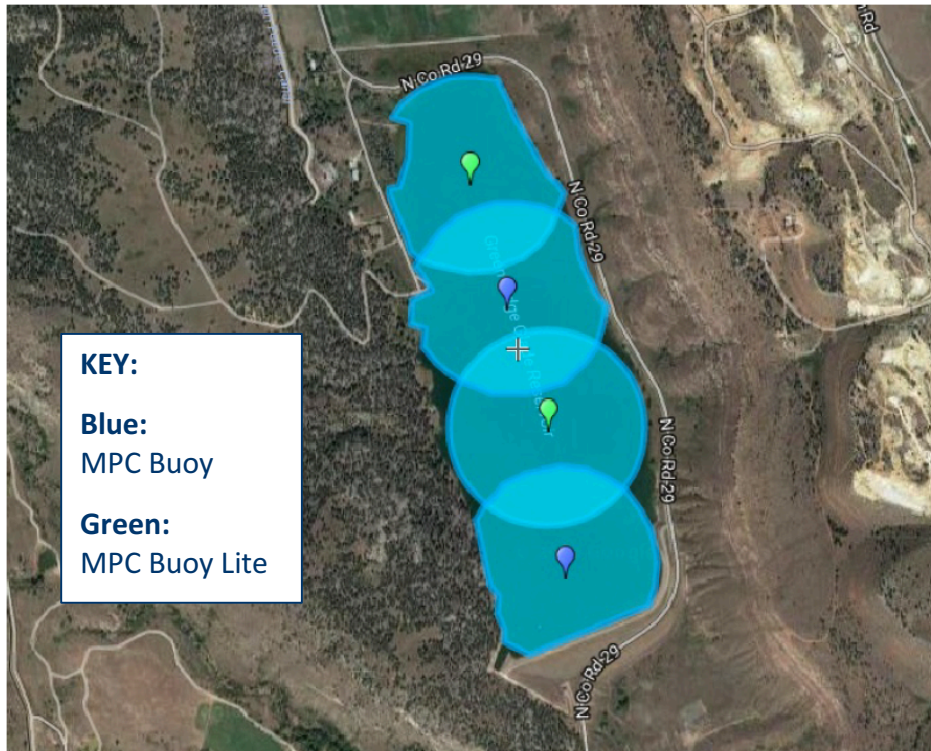

*Benefits and Drawbacks*

The benefits and drawbacks of the LG Sonic technology are shown in Table 3. There are few drawbacks of this technology and very few unforeseen impacts on water quality or the environment. In addition to the equipment purchase, LG Sonic recommends an annual service contract of \$11,500/year for calibrating the water quality sensors and fine tuning the ultrasonic frequency for more targeted algal mitigation.

Table 3 Benefits and drawbacks of the LG Sonic ultrasound technology

Benefits	Drawbacks
<ul style="list-style-type: none"> <li>• No byproducts</li> <li>• Environmentally friendly</li> <li>• No impact on fish species, plants, or insects</li> <li>• 60-90% bloom reduction expected</li> <li>• Reduces chemical application</li> <li>• Provides water quality monitoring</li> </ul>	<ul style="list-style-type: none"> <li>• Service contract for tuning and calibration (\$11,500/year)</li> <li>• Does not address Mn or other water quality challenges</li> <li>• May promote growth of benthic algae</li> <li>• 3 to 5-year guarantee</li> </ul>

*Capital Costs*

The capital costs for the LG Sonic ultrasound technology are \$176,000, inclusive of installation, initial training, and a spare parts package and are shown in Table 4. Operational costs are low because the MPC Buoy and MPC Buoy Lite are equipped with solar panels run by solar energy.

The annual service contract cost is the main operational cost associated with the LG Sonic ultrasound technology.

*Table 4 Installed capital cost for the LG Sonic MPC Buoy technology*

<b>Equipment</b>	<b>List Price</b>	<b>Quantity</b>	<b>Subtotal</b>
<b>MPC Buoy</b>	\$45,000	2	\$90,000
<b>MPC Buoy Lite</b>	\$32,500	2	\$65,000
<b>Spare Part Package</b>	\$14,500	1	\$14,500
<b>Supervision of Installation and Setup</b>	\$ 6,500	1	\$ 6,500
		<b>Total</b>	<b>\$176,000</b>

The design and configuration of the MPC Buoy and MPC Buoy Lite equipment can be optimized further. A MPC Buoy Lite can be converted to a MPC Buoy at a later date by retroactively installing the water quality analyzer sensors.

### R3. Reservoir Mixing

#### *Description of Technology*

Mixing can be an effective means for algal mitigation by preventing stratification, and thus seasonal turnover. The mixing system works by withdrawing water and pumping it to different levels within the water column, thus preventing both seasonal nutrient release, and maintaining minimal biological growth. As with the ultrasonic approaches, there are multiple vendors that offer reservoir mixing products. For the purpose of this assessment, Medora Solarbee was solicited to cost and installation details.

Medora offers systems capable of mixing both the upper (epilimnion) and lower (hypolimnion) portions of the Reservoir. Mixing in the hypolimnion will prevent manganese release during reservoir turnover. That said, manganese can be managed either by managing which intake gate in use and through the use of chlorine dioxide in the plant. The required mixing energy is dependent on the hydraulic residence time within the reservoir. When there is a longer hydraulic residence time, less mixing is required. LWP occasionally withdraws up to 28 MGD from the reservoir, but has an average withdraw rate of 9.8 MGD. The system must be sized for the lower withdraw rate corresponding to a higher residence time. Medora provided proposals assuming average day withdrawal of 9.8 MGD from the Reservoir. For a 9.8 MGD withdraw rate, 4 epilimniotic mixers and 6 hypolimniotic mixers will be necessary. The installation locations of the epilimniotic and hypolimniotic mixers are shown in Figure 11. When LWP withdraws a greater volume than average from the reservoir, fewer mixers are required to be in service at a time.

Figure 11 Proposed installation locations for Medora's SolarBee technology

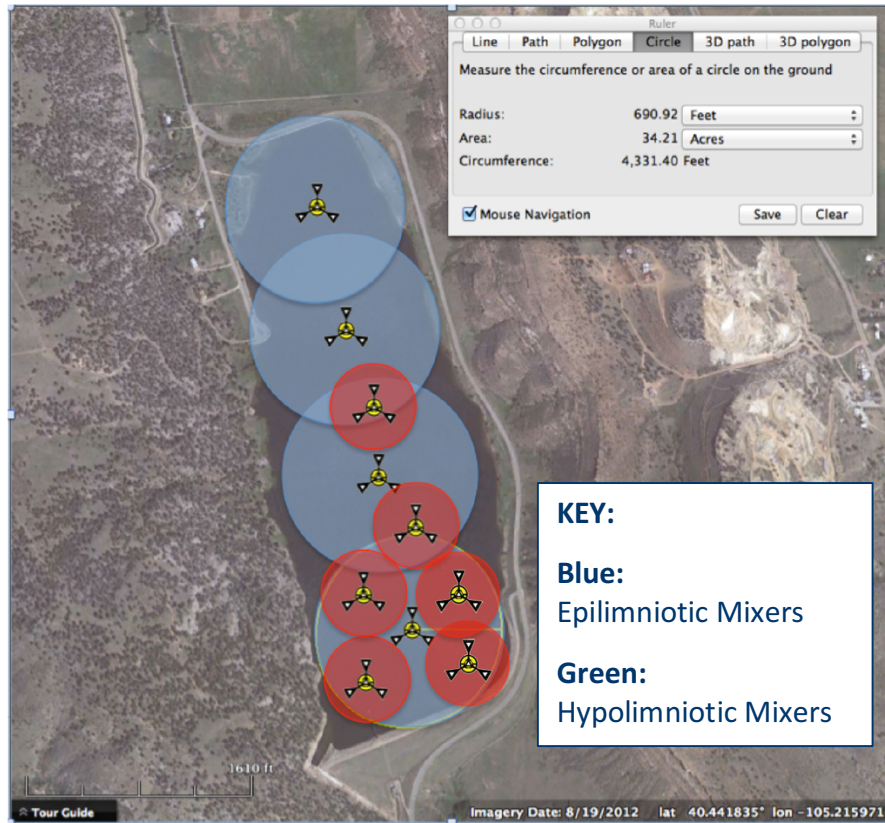

*Benefits and Drawbacks*

Benefits and drawbacks for Reservoir mixing are shown in Table 5.

Table 5 Benefits and drawbacks of mixing with Medora SolarBee technology

Benefits	Drawbacks
<ul style="list-style-type: none"> <li>• Minimal environmental impact including effects on fish species, plants, and insects</li> <li>• No chemical additive or chemical byproduct</li> <li>• Rental agreement and short timeline possible</li> <li>• Prevents stratification</li> </ul>	<ul style="list-style-type: none"> <li>• Potential water quality challenges from homogenizing the water column with use of hypolimnetic mixers</li> <li>• Highest capital cost among active reservoir strategies if both epilimnetic and hypolimnetic mixers are used</li> </ul>

*Capital Costs*

The capital costs for Medora’s SolarBee technology are shown in Table 6. If selected, Medora offers an additional option for equipment procurement in the form of a 12-month rental. Annual rental rates for the equipment are also shown in Table 6. Following a successful 12-month rental, the units can be purchased with zero additional installation cost (included in capital) and with

50% discounted equipment costs. Medora also offers refurbished units with a 15% discount and provide an “as new” warranty.

*Table 6 Medora SolarBee cost outcomes for 9.8 MGD withdraw rates from the reservoir*

<b>Flow</b>	<b>9.8 MGD</b>
<b>No. in Hypolimnion</b>	6
<b>No. in Epilimnion</b>	4
<b>Cost Hypolimnion (\$)</b>	\$335,000
<b>Cost Epilimnion (\$)</b>	\$197,000
<b>12 Mo. Rental (\$)</b>	\$205,000
<b>Purchase Cost (\$)</b>	\$532,000

R4. Dissolved Oxygen Augmentation

*Description of Technology*

Eco2 offers the Speece Cone, dubbed as a “super oxygenation system” designed to increase dissolved oxygen in the Reservoir. Effectively, the Speece Cone uses a liquid oxygen feed system, coupled with fluid dynamics, to promote the dissolution and delivery of oxygen rich water to the lower portions of the Reservoir. Higher dissolved oxygen at lower levels of the Reservoir creates an aerobic cap above sediments, preventing nutrient and manganese release. Recently, Denver Water installed a Speece Cone in their Marston Reservoir. In one season, dissolved oxygen concentrations in Marston Reservoir have increased from anoxic (<0.5 mg/L as O<sub>2</sub>) to above 7 mg/L as O<sub>2</sub>.

The proposed location of the Speece Cone is shown in Figure 12 by the yellow marker on the southwest side of the Reservoir.

*Figure 12 Proposed installation location for the Eco2 Speece Cone at the Green Ridge Glade Reservoir*



Eco2 provided preliminary system sizing information. Table 7 shows the sizing information provided by Eco2. The target oxygen dissolution rate is 1,800 lbs./day of O<sub>2</sub>, with a design capacity of 1,950 lbs./day.

*Table 7 Design details for the Eco2 Speece Cone*

<b>Eco2 System Design</b>	<b>On-Shore Installation</b>
<b>System Size (dia., ft)</b>	6
<b>System Height (ft)</b>	15
<b>Sidestream Flow (gpm)</b>	2,800
<b>Sidestream HP</b>	54 HP
<b>Discharge D.O. (mg/L)</b>	63
<b>O<sub>2</sub> Dissolution Capacity (lbs./day)</b>	1,950

*Benefits and Drawbacks*

The benefits and drawbacks of this technology are summarized in Table 8.

*Table 8 Benefits and Drawbacks for the Eco2 Speece Cone*

<b>Benefits</b>	<b>Drawbacks</b>
<ul style="list-style-type: none"> <li>• Targeted dissolved oxygen augmentation at certain depths</li> <li>• Increases dissolved oxygen in the reservoir</li> <li>• Consumables (liquid oxygen) are available locally and relatively inexpensive</li> <li>• Assists in manganese control</li> </ul>	<ul style="list-style-type: none"> <li>• May cause increase in T&amp;O producing algae</li> <li>• Requires onsite liquid oxygen or direct oxygen line</li> </ul>

*Capital Costs*

The Eco2 Speece Cone capital costs are shown in Table 9. For the purposes of this cost estimate, it was assumed that the Speece Cone will be installed on the Reservoir shore. Alternatively, the Speece Cone can be installed with weights on the Reservoir floor. There is a substantial increase in cost if Reservoir bottom installation is required, and an extensive soil evaluation of deposited sediment in the Reservoir will also be necessary. With the on-shore installation, the total capital cost of the Eco2 Speece Cone is \$294,000.

Table 9 Eco2 Speece Cone capital costs

Component	On-shore Installation
Eco2 System	\$230,000
Oxygen Flow Control	Included
Sidestream Pump	\$60,000
Shipping	\$4,000
<b>Total Capital Cost</b>	<b>\$294,000</b>

*O&M Costs*

A liquid oxygen supply is required for the Eco2 Speece Cone oxygenation system. Praxair is local gaseous chemical supplier with an existing distribution center in Loveland, CO and has developed preliminary cost estimates for a liquid oxygen tank, service contract, and bulk chemical delivery. Table 10 shows the liquid oxygen supply costs for the Eco2 Speece Cone technology. The estimated monthly rate is \$3,200, inclusive of electrical, storage tank rental, and chemical delivery.

Table 10 Liquid oxygen supply costs for the Eco2 Speece Cone

Component	Praxair System
Liquid O <sub>2</sub> Cost (58,500 lbs/month)	\$0.03/lb
Monthly Tank Rental (\$/month)	\$900
Compliance Charge (\$/delivery)	\$60
<b>Monthly Cost (\$/month)</b>	<b>\$3,200</b>

R5. Emerging Technology for Phosphorus Removal (Biochar Now)

Biochar Now supplies specially manufactured biochar from biological sources for adsorption of nutrients, particularly phosphorus, from the Reservoir, thus limiting algal growth. In concept, the biochar packed in a sock-like cloth and sunk to various depths in the Reservoir where it can passively adsorb nutrients. LWP staff performed a series of jar-tests with varying Biochar Now doses to assess the phosphorus removal capacity. The preliminary results showed no phosphorous removal. At this time Biochar Now is not considered for application in the Reservoir and further research and testing should be conducted to determine if utilizing Biochar Now would be beneficial for LWP.

WTP Alternatives

W1. Exercising Various Gates within the Intake Tower

As discussed previously, the water quality in various depths in the Reservoir vary significantly. While algae cell counts and T&O causing compounds occur at higher concentrations near the surface, manganese spikes occur closer to the bottom of the Reservoir (see Figure 6). The intake tower for the LWP WTP has six gates at various levels, as shown in Figure 13. Historically, LWP has used gates 4 and 5 for withdrawing water.



The water quality data from Site 4, should be used to inform which gate is operated. Given that the Geosmin concentrations are typically lowest at the bottom of the Reservoir (Figure 6), exercising gate 6, the lowest gate could alleviate Geosmin entering the WTP during T&O events. However, during periods of manganese release it a higher gate may be preferred to prevent high levels from entering the WTP. Knowing there is preparation required before changing gates, this operational strategy will require close communication between operations and the water quality staff.

Figure 13 Gates along the WTP intake tower in the Green Ridge Glade Reservoir

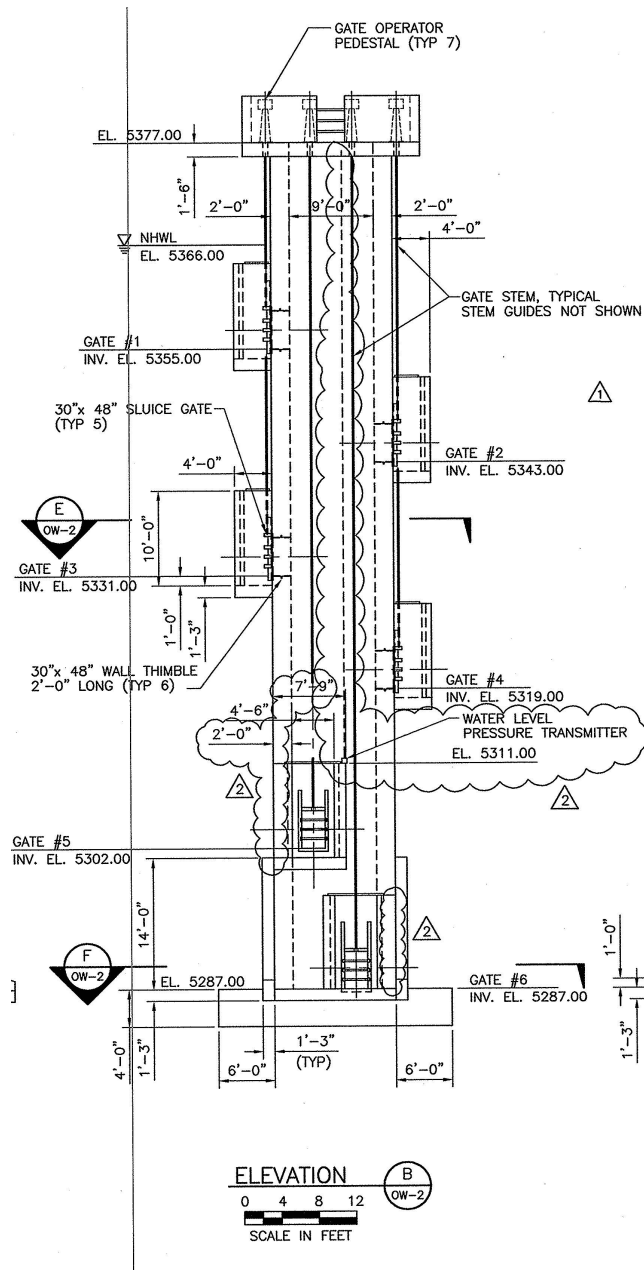

#### W2. Pre-oxidation (Chlorine Dioxide)

The LWP currently uses chlorine dioxide as a pre-oxidant to control manganese and may also assist with T&O mitigation. If chlorine dioxide were used for T&O mitigation it is likely that significantly higher doses would be required. However, higher chlorine dioxide doses will result in cell lysis, potentially releasing higher concentrations of T&O compounds. Additionally, cyanotoxins are currently on the regulatory horizon and cyanotoxin concentrations can also increase with cell lysis. As such, use of chlorine dioxide for management of T&O causing compounds is not recommended at the LWP WTP.

#### W3. Powdered Activated Carbon (PAC)

PAC is often used as T&O control strategy as it has the capability to remove Geosmin through adsorption. The WTP currently has the capability to feed PAC. LWP currently uses Hydrodarco B from Cabot Norit which is typically applied at a dose of less than 10 mg/L, however as a result of operational changes LWP was able to feed a maximum PAC dose of 16 mg/L. LWP could see a greater return from their PAC feed through an optimization study.

The optimization study would involve: (1) Screening of LWP's currently used PAC with other products to compare relative performance, and (2) Determining the appropriate PAC doses that will be necessary to achieve treated water T&O target concentrations.

LWP staff have expressed interest in optimizing their PAC treatment strategy. Recently, Corona has performed a similar analysis for a drinking water utility in Louisiana. This utility used Hydrodarco C, a coarser mesh size of the product used by LWP. Through this study, it was found that alternative products yielded 45% more T&O removal at a given dose. It is recommended that LWP perform a similar study to evaluate the effect of alternate PAC types on T&O removal. Once the appropriate PAC dose is identified, the results will inform if the existing feed and storage system is adequate or if capital improvements are required.

#### W4. Granular Activated Carbon (GAC) Filter Caps

GAC is frequently used by surface water utilities as an adsorbent media for organic contaminant removal, such as T&O. GAC is also used to reduce disinfection by-product (DBP) formation by removing the precursor compounds. Given the existing infrastructure at the WTP, GAC filter caps could be considered by added approximately 11.5 inches of GAC to the existing filter boxes. GAC filter caps need to be replaced after the adsorption capacity is exhausted, requiring routine maintenance. GAC filter cap details and costs have been developed based on Geosmin removal and are shown in Table 11.

Table 11 Design and cost details for filter cap installation

Component	GAC System Cost
GAC per Vessel (lbs.)	8,000
GAC Depth (in)	11.5
Initial GAC Cost (\$/lb.)	\$1.65
Initial GAC Cost (\$)	\$264,000
GAC Bedlife (yr)	2
Future Virgin GAC Cost (\$/lb)	\$1.75
Future Virgin GAC Cost (\$)	\$280,000

The initial GAC cost is \$264,000, inclusive of installation by Calgon Carbon. Numerous other local utilities utilize GAC for T&O removal. Calgon’s initial estimate is that GAC replacement will occur once annually. However, recent success with the GAC system in Arvada suggests that it is reasonable to expect a 2 year GAC replacement frequency. It is estimated that the cost for each GAC replacement event is is \$280,000.

#### W5. Advanced Oxidation Processes (AOP)

Advanced oxidation processes (AOP) rely on the formation of highly reactive hydroxyl radicals which can then oxidize organics and inorganics in water. AOPs require a combination of ultraviolet (UV) light with either ozone or hydrogen peroxide to generate hydroxyl radicals. These systems require significant capital expenditures and also have high operations and maintenance cost. Additionally, AOPs will require extensive pilot testing and design prior to implementation. As such, AOPs are not the most effective strategy for T&O control at the WTP, and were not considered in detail as part of this project.

### Alternatives Selection Decision Matrix

As described above, each of the potential algae mitigation strategies have associated benefits and drawbacks. To facilitate the selection of the LWP’s most appropriate mitigation strategy, an in-person workshop was conducted on January 24<sup>th</sup>, 2017 with various stakeholders to discuss each alternative, solicit input and develop consensus for on the selected alternatives for implementation.

#### Summary of Alternative Analysis

The recommended approach for algal and T&O management is a multiple barrier approach that will include both Reservoir and WTP control strategies. To facilitate the decision making process, comparative summaries were developed for Reservoir chemical treatment, Reservoir physical treatment, and WTP treatment alternatives. Table 12 shows the summary for the Reservoir chemical treatment options evaluated.

Table 12 Comparative summary for the Reservoir chemical treatment options evaluated

Evaluation Criteria	Copper Sulfate	PAK 27	Lonza Chemicals	SOLitude Chemicals
Effective for algae control	Yes	No	Maybe	Maybe
Copper-based product	Yes	No	Both	No
Effects on “non-target” species	Yes	Yes	Maybe	Maybe
Third party application	No	No	Yes	Yes

Given the ineffectiveness of PAK27 application (Figure 8) and the CDPS copper limits, LWP should pursue the use of alternative chemicals for algae control. Based on this analysis, products from either Lonza or SOLitude may prove to be effective. As discussed earlier, once algae growth is observed in the Reservoir in 2017, the chemical suppliers should test and recommend appropriate chemicals and recommended doses for application. The service contracts with the chemical suppliers for Reservoir treatment need also be reviewed and negotiated. The chemical supplier and appropriate algae control chemical should be finalized prior to Summer 2017.

Chemical treatment alone will not be sufficient to manage the algal challenge; physical treatment will also need to be installed in the Reservoir for algal mitigation. Table 13 shows the comparative summary for the physical treatment alternatives evaluated.

Table 13 Comparative summary for the physical installations in the reservoir

Evaluation Criteria	Reservoir Mixing (Medora SolarBee)	Dissolved Oxygen Augmentation (ECO2 Speece Cone)	Ultrasonic Treatment (LG Sonic)	Emerging Technology for Phosphorus Removal (Biochar Now)
Effective for algae control	Maybe	Maybe	Yes	Maybe
Minimal aesthetic impact	Yes	No	Yes	Yes
Technical maturity	Yes	Maybe	Maybe	No
Operational complexity	Low	High	Low	Unknown

Based on the outcomes shown in Table 13, Eco2 Speece Cone and Biochar Now are not suitable options for LWP’s reservoir. Eco2 Speece Cone will augment the dissolved oxygen within the Reservoir and while it may reduce anoxic activity, it may facilitate growth of algae species that

were previously dissolved oxygen limited. LWP has evaluated Biochar Now in a limited capacity and preliminary results do not show a significant benefit in phosphorus removal.

The Medora SolarBee mixing technology and the LG Sonic ultrasound technology are both viable alternatives for the LWP Reservoir. However, the Medora SolarBee mixing technology has uncertainty over the specific effect on algae species, whereas the LG Sonic ultrasound technology is specifically designed for algal mitigation.

LG Sonic is based out of the Netherlands, and is relatively new to the United States market. However, LG Sonic has a number of installations in Europe in similar climates to Colorado’s Front Range that have been successfully operating for years. In the limited applications in the United States where the technology has been deployed (i.e. New Jersey American Water and Consolidated Mutual Water Company), the results have been encouraging and consistent with those overseas. As such, it is recommended that LWP proceed with implementation of the LG Sonic ultrasonic equipment for algal mitigation in the Green Ridge Glade Reservoir.

The final barrier in the multiple barrier approach is to utilize the processes within the WTP for algae and T&O control. Table 14 shows the comparative summary for the WTP treatment alternatives.

*Table 14 Comparative summary of the WTP alternatives*

Evaluation Criteria	Intake location	Pre-oxidation	PAC	GAC filter caps	Advanced oxidation processes
Effective for T&O control	Yes	Maybe	Yes	Yes	Yes
Effective for algal cell removal	No	No	No	Yes	No
Maintains algal cell structure	Yes	No	Yes	Yes	No
Easy to retrofit within existing WTP processes	Not Applicable	Yes	Maybe	Maybe	No
Intermittent use possible	Yes	Yes	Yes	No	Yes

Closely monitoring and managing the intake location is a non-cost approach and could be implemented immediately. By informing the operation of the intake structure based on water quality results, it is likely the T&O compounds and algae entering the plant could be minimized during much of the year.

LWP currently uses chlorine dioxide for pre-oxidation. Given the potential for algal cell lysis, it is uncertain if chlorine dioxide will be effective for control of T&O compounds. As such, pre-

oxidation with chlorine dioxide is not recommended for primary T&O control at the WTP, but the dose could be further optimized for effective preoxidation.

PAC is commonly used to remove T&O compounds. Based on the benefits shown in Table 14, optimizing the current PAC feed system is the recommended treatment strategy for T&O control. A PAC optimization study should be conducted to determine the most effective product and dose conditions. With the limited capacity of the PAC feed and storage system, upgrades may be required to effectively use PAC to mitigate T&O events. As described in the following section, bench-scale testing is necessary to determine the most appropriate PAC product, effective dose, and to develop the design criteria for any required modifications to the storage and feed systems.

GAC filter caps are also a viable option for T&O mitigation. However, GAC filter cap costs are high and will require periodic media replacement, which is estimated to cost \$280,000 for each replacement. The replacement frequency could range from 6 months to 2 years. Due to the uncertainty in replacement frequency and relatively high replacement costs, it is recommended that LWP optimize their current PAC application strategy prior to considering GAC filter caps further.

Advanced oxidation processes (AOPs) provide additional water quality benefits beyond T&O control, but they also require substantial capital improvements and have high operational and maintenance costs. As such, AOPs are not recommended for T&O control.

## Recommendations

Based on the above analysis and input from the in-person workshop, the following is the recommended strategy for algae and T&O control at the LWP Reservoir and WTP. While outside the scope of this project, an effective communications plan is key to addressing T&O events, and as such recommendations for implementation of a communications plan are included:

### Reservoir

- **Continue T&O monitoring program** in the Reservoir and source waters year-round, with increased frequencies during algal presence in the Reservoir. LWP already has a robust monitoring program. To better inform the mitigation strategies, additional water quality parameters such as phycocyanin and UV-254, should be included in the routine monitoring.
- **Select a new chemical for algae treatment** different from the previously used copper sulfate and PAK27. Chemicals provided by either Lonza or SOLitude can be effective for algae control in the Reservoir. See Next Steps section below for selection process for the appropriate chemical and supplier
- **Install ultrasonic treatment equipment supplied by LG Sonic** in the Reservoir. A number of design parameters and operational considerations still need to be addressed for optimal performance. See Next Steps section below that outlines the implementation roadmap for the ultrasonic equipment.

## WTP

- **Exercise various gates within the WTP intake tower** to withdraw water with the best quality from the Reservoir. WTP operational staff should be familiar with the Reservoir Monitoring Site 4 water quality in order to make informed decisions regarding the use of the most appropriate intake gates. The WTP intake tower has six gates.
- **Determine the most appropriate PAC treatment strategy** for T&O control within the WTP. This includes determination of the appropriate PAC product, dose, and understanding of the necessary upgrades to the PAC storage and feed system. See Next Steps section below for development of the optimal PAC treatment strategy for T&O control.

## Communications

- **Develop plans and templates for both internal and external communications** prior to, during and after T&O events
- **Include details within the communications** to explain cause(s) of the T&O issue, whether the water is still safe to drink or use, and actions taken by LWP to address the issue. Provide clear guidance on any steps that can be taken by customers to mitigate T&O in their premises
- **Tailor communications for different audiences**, e.g. customers, board members, regulatory agencies, etc.

## Next Steps

In order to implement the recommendations for algal and T&O mitigation as outlined above, the following next steps are suggested. Corona can assist LWP with all of these items, as needed:

- **Selection of appropriate supplier and chemical(s) for Reservoir chemical treatment:** When algae growth starts occurring in the Reservoir in 2017, LWP should request the chemical suppliers (Lonza and/or SOLitude) identify the appropriate treatment chemical(s). The steps related to chemical treatment in the Reservoir are for the suppliers to determine the appropriate chemical(s), recommended doses, application frequency, and provide costs estimates. Chemical suppliers may choose to perform limited testing to determine appropriate chemical(s). Once the recommendations are received from the suppliers, in-house testing with the selected chemical should be performed in order to determine effects, if any, on other water quality parameters in the Reservoir. Effects of the chemical on other non-target species (vertebrates, invertebrates, etc.) need to be determined as well. Additionally, a service contract should be established that outlines roles and responsibilities of each party, along with costs of services. The service contract should be flexible in terms of the number of fixed frequency chemical applications, as well as, “as needed” applications.
- **Implementation of LG Sonic ultrasonic treatment equipment within the Reservoir:** This is a major capital investment for LWP, and as such, the following items are critical prior to equipment installation:

- Finalize design, and develop specifications for ultrasonic equipment, water quality analyzers, solar panels, anchoring or mooring systems, etc.
- Obtain final cost proposals for both capital and annual maintenance costs from LG Sonic. Clarify warranties on different pieces of equipment
- Obtain feedback from other water utilities in the U.S. that have implemented LG Sonic ultrasonic equipment
- Determine additional equipment and/ or supplies that may not be included within the LG Sonic scope of supply, and will need to be provided by LWP (anchoring reinforcements, protection of solar panels, etc.)
- Develop installation plan including schedule, manpower, support equipment or tools that may be necessary during equipment installation
- Discuss data acquisition and storage for LWP's use and optimization of equipment performance that may be necessary
- Establish maintenance contract for ultrasonic transmitters, batteries, and water quality sensors
- ***Development of an optimal PAC treatment strategy for T&O control within the WTP:*** A number of PAC products, including LWP's currently used PAC, should be screened to determine the T&O removal capacity. In addition to T&O removal, it is highly recommended that cyanotoxins are considered as part of the PAC screening process. Cyanotoxins are in the regulatory horizon, and are included for monitoring as part of the Unregulated Contaminant Monitoring Rule 4 (UCMR 4). PAC screening can be performed through bench-scale testing. The entire process train should be simulated in bench-scale testing, including chlorine dioxide. The effects of chlorine dioxide on algal cell lysis, T&O control and cyanotoxins should be evaluated. Through the PAC screening process, the most effective product, dose, and injection point will be determined. As part of the same effort, design criteria for full-scale improvements identified including; necessary storage capacity, feed system pumping and conveyance, and slurry tank sizing will be determined.



## Appendix A –Vendor Proposals

# Algae Control Proposal



Corona Environmental Consulting

Prepared by

Lisa Maria Brand

[l.brand@lgsonic.com](mailto:l.brand@lgsonic.com)

+31707709032

19-12-2016

## Executive summary

In this proposal you will find an installation advice for monitoring and controlling algae in the Green Ridge Glade Reservoir.

### Benefits for ultrasonic algae control

- Reduce algal blooms by up to 70-90%
- Prevent growth of algae
- Reduce chemical use
- Payback period of ±1.8 years

### Ultrasound technology

In all water bodies, a basic level of algae is present. These algal concentrations belong to the normal lake ecology and are also important for the ecological balance within the water. However, when a specific algal type starts growing exponentially, it can suffocate other organisms within the water that are important for a balanced lake ecology. The ultrasonic algae control devices from LG Sonic emit specific ultrasonic parameters to control algae in lakes, reservoirs, and industrial applications. Ultrasound waves create a sound layer in the top layer of the water, which has a direct impact on the buoyancy of the algae. The algae cells will sink to the deeper and darker layers of the water column and are unable to photosynthesise, thus will eventually die due to a lack of light.

### The advantages of ultrasound technology

- No release of toxins
- Environmentally friendly
- Safe for fish, plants, zooplankton and insects

### Project proposal

Based on the dimensions of the reservoir, we advise to install a total of 4 MPC-Buoy systems. The MPC-Buoy is a floating, solar powered, platform that combines continuous online water quality monitoring, web-based software, and ultrasonic technology to effectively control harmful algal blooms in large water surfaces, such as lakes and larger ponds.

### Similar projects



## Total project costs

Table 1: Total project costs

Product details	List price	Quantity	Subtotal
MPC-Buoy	\$45,000.00	2	\$90,000.00
MPC-Buoy Lite	\$32,500.00	2	\$65,000.00
Spare part package MPC-Buoy	\$14,500.00	1	\$14,500.00
Supervision of Installation and Setup	\$6,500.00	1	\$6,500.00

**Grand total    \$176,000.00**

## Table of contents

### **1. Treatment proposal**

- 1.1. Proposed solution
- 1.2. Proposed installation
- 1.3. Initial costs
- 1.4. Maintenance and annual service costs

### **2. Specifications**

- 2.1. Concept: monitor, predict and control algae
- 2.2. Key system elements
- 2.3. Technical specifications

### **3. Delivery and guarantee**

- 3.1. Delivery method
- 3.2. Guarantee

### **4. LG Sonic company profile**

## 1. Treatment proposal

The Green Ridge Glade Reservoir is a relatively deep reservoir that in the past has suffered from seasonal algae blooms and associated problems with taste and odour molecules produced by cyanobacteria. Algae analysed in the reservoir have mainly been *Anabaena*, a blue-green algae that is known for producing the MIB molecule, and in some occasions geosmin, which are both known for causing problems with taste and odour of the finished drinking water. The algae control systems developed by LG Sonic offer an environmentally friendly solution to control algae by making use of ultrasound waves.

### 1.1. Proposed solution

Based on the dimensions of the reservoir, we advise installing a total of 4 MPC-Buoy systems.

The MPC-Buoy is a floating, solar-powered platform that combines continuous online water quality monitoring, web-based software, and ultrasonic technology to effectively control harmful algal blooms in large water surfaces, such as lakes and larger ponds. The MPC-Buoy eliminates up to 90% of the existing algae and prevents the growth of new algae.

One MPC-Buoy system can treat large surface areas up to 500-meter (1600 ft) diameter coverage. The MPC-Buoy is anchored in the centre of the lake, ensuring correct coverage of the ultrasound waves.



## 1.2. Proposed installation

Below you will find an installation plan for Green Ridge Glade Reservoir. A total of 4 MPC-Buoy systems will be anchored in the reservoir. The blue icons are MPC-Buoy systems and the yellow icons MPC-Buoy Lite systems. The MPC-Buoy Lite systems do not contain water quality sensors since it is not necessary to measure the water quality every 500 meters; this way, we can offer our customers a more cost-effective solution. Each buoy system has a treatment range of 500-meter diameter coverage, so when you install 4 MPC-Buoy systems the entire pond is covered with ultrasound.

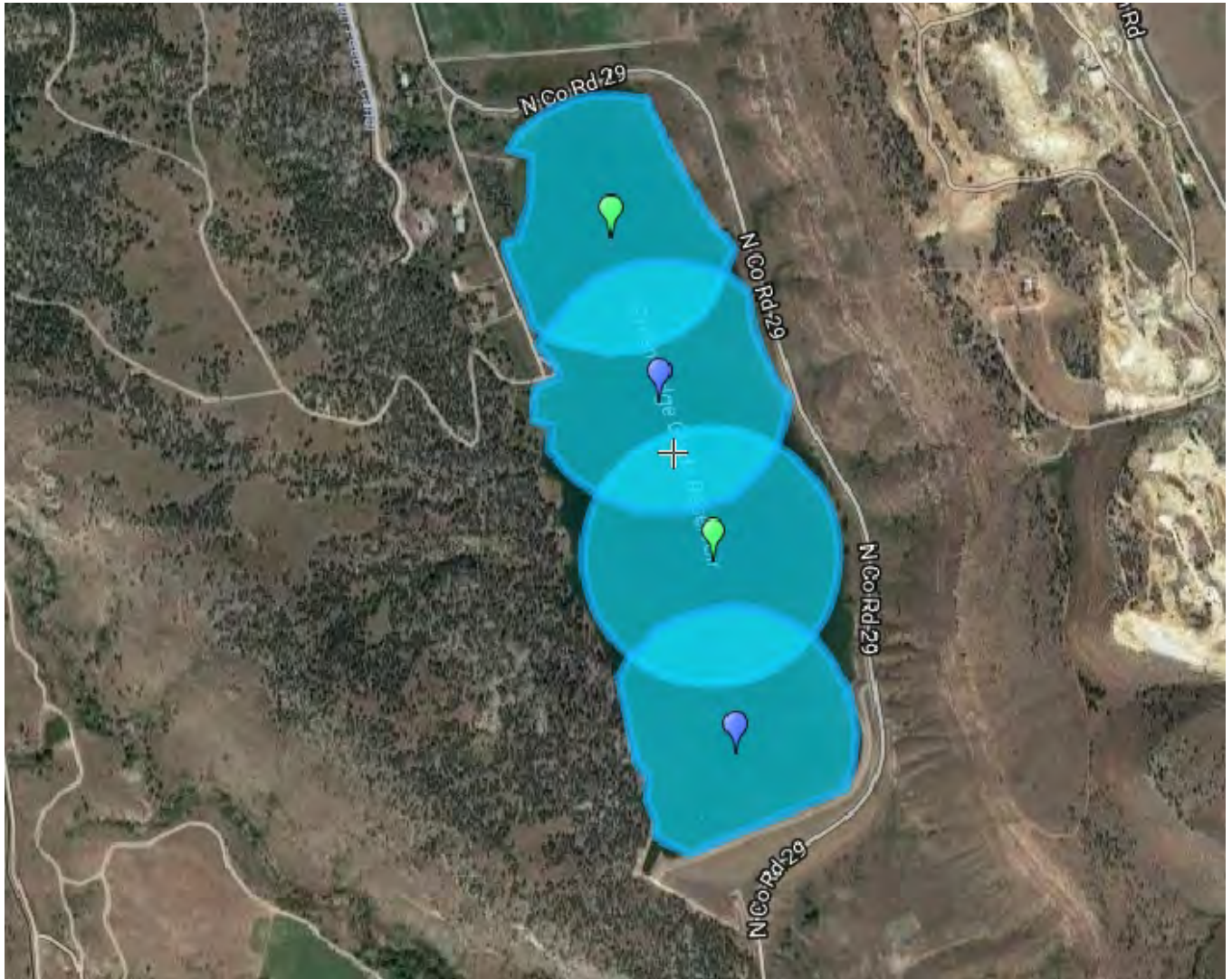

## FAQ

### **Is ultrasound harmful for fish, plants, zooplankton, or insects?**

No. The effects of LG Sonic products have been tested by various universities and are proven to be safe for fish, plants, zooplankton, and insects.

### **What happens to the algae after the ultrasonic treatment?**

The ultrasound creates a sound layer in the top layer of the water. This ultrasonic sound barrier prevents the algae from rising to the surface and absorbing light for photosynthesis. Therefore, algae are no longer capable of growing further. The algae will die while the cell wall remains intact, preventing the release of toxins from the algae into the water. The algae will sink to the bottom of the water reservoir and are degraded by the bacteria present.

### **Does the algae release toxins in the water?**

Algae control by ultrasound is based on the interference with their buoyancy and hence preventing their photosynthetic activity. Ultrasound does not break or lyse the cells, and as such toxins are not released into the water. As the ultrasound process is generally a longer process (3-4 weeks) and growth of new algae is being prevented, you can see a gradual reduction in toxin concentration once ultrasound is introduced.

### **How is the system installed?**

The MPC-Buoy is anchored in the water reservoir. Each system has 4 ultrasonic transmitters ensuring complete 360-degree sound coverage.

Do you want to receive more information or have any other questions? Please contact your account manager.



### 1.3. Initial costs

Table 2: Total project costs

Product details	List price	Quantity	Subtotal
MPC-Buoy	\$45,000.00	2	\$90,000.00
MPC-Buoy Lite	\$32,500.00	2	\$65,000.00
Spare part package MPC-Buoy	\$14,500.00	1	\$14,500.00
Supervision of Installation and Setup	\$6,500.00	1	\$6,500.00

**Grand total    \$176,000.00**

Table 3: Product/service description

Product/Service	Amount	Included
MPC-Buoy	2	<ul style="list-style-type: none"> <li>● Ultrasonic treatment</li> <li>● Water quality sensor package</li> <li>● Solar panels</li> <li>● 1-year of interactive algae control services</li> <li>● Web-based software package</li> <li>● Floating buoy construction</li> </ul>
MPC-Buoy Lite	2	<ul style="list-style-type: none"> <li>● Ultrasonic treatment</li> <li>● Solar panels</li> <li>● 1-year of interactive algae control services</li> <li>● Web-based software package</li> <li>● Floating buoy construction</li> </ul> <p>The MPC-Buoy lite receives ultrasonic program updates from the MPC-Buoy in lakes where more than one buoy is required</p>
Installation	1	Installation supervision and start-up of the software

## Recommended by LG Sonic

Table 4: Recommended product/service description

Product/Service	Amount	Included
Spare parts package	1	<ul style="list-style-type: none"><li>● 1 Transmitter + aquawiper</li><li>● 1 Regulator</li><li>● 1 Ultrasonic box</li><li>● 1 Datalogger box</li><li>● 1 USB cable</li><li>● 1 Antenna</li><li>● 1 cable regulator/datalogger box</li><li>● 1 cable datalogger box / Ultrasonic box</li><li>● 4 solar extension cables</li><li>● 1 transmitter arm left</li><li>● 1 transmitter arm right</li><li>● Bolts + nuts</li></ul>

## 1.4. Maintenance and annual service costs

The sensors and ultrasonic transmitters on the MPC-Buoy are all equipped with wipers to ensure they stay clean. This keeps the efficiency and specificity of the MPC-Buoy optimal and makes frequent maintenance to the system redundant.

Besides that, the technical status of the system can also be monitored through the MPC-View software, minimizing visits to the MPC-Buoy itself. What is left for maintenance is the calibration of the sensors. LG Sonic can do this for you simply by you sending the sensor package to us once a year.

We recommend performing an on-site physical inspection bi-monthly to check the state of all the parts comprising the MPC-Buoy.

Table 5: Maintenance and annual service costs

Type	Included	Costs
Interactive algae control services	<ul style="list-style-type: none"> <li>Interactive algae control services</li> <li>Data management</li> <li>Web hosting</li> <li>Setup of server</li> <li>Software licensing</li> </ul>	<p>The first 12 months are included in the price. After 12 months, use can be paid for on a yearly basis:</p> <ul style="list-style-type: none"> <li>First MPC-Buoy: \$7.500/year</li> <li>First MPC-Buoy lite: \$1.250/year</li> <li>Additional MPC-Buoy: \$1.125/year</li> <li>Additional MPC-Buoy lite: MPC-Buoy: \$375/year</li> </ul>
Calibration of the water quality sensors	<ul style="list-style-type: none"> <li>Fluorobrobe (phycocyanin, turbidity, Chlorophyll a)</li> <li>DO sensor</li> <li>Replacement of pH cartridge</li> <li>Revision of sensor wiper engine</li> </ul>	\$1.250/ year

## 2. Specifications

### 2.1. Concept: monitor, predict and control algae

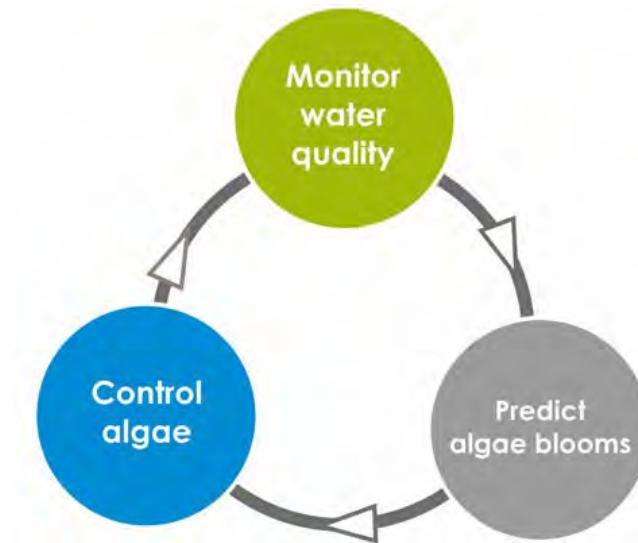

The MPC-Buoy is specially designed for large water surfaces and combines online water quality monitoring, web-based software and ultrasound technology to provide complete and cost-effective treatment against algae in lakes, ponds and drinking water reservoirs.

#### 1. Monitor water quality

The MPC-Buoy provides a complete overview of the water quality by collecting the following parameters every 10 minutes: Chlorophyll  $\alpha$  (green algae), Phycocyanin (blue-green algae), pH, Turbidity, Dissolved Oxygen, and Temperature.

#### 2. Predict algal blooms

The collected data is delivered in real time via radio, GPRS, or 3G to web-based software. Based on our developed algorithm we are able to modify the ultrasonic program to the specific water conditions and predict algal blooms a few days ahead.

#### 3. Control algae

Based on the received information, the ultrasonic program can be activated according to the water conditions and type of algae present. In this way, it is possible to eliminate existing algae and prevent the growth of new algae.

## 2.2. Key system elements

1. Ultrasonic treatment
2. Water quality sensor package
3. Solar panels
4. Floating construction anchored at the bottom of a lake
5. Data communication for remote control
6. Water quality software package



## 1. Ultrasonic treatment for algae control

The MPC-Buoy is equipped with 4 ultrasonic transmitters for 360-degree algae control. Each transmitter has an ultrasonic treatment range of 500m/1600ft in diameter. Based on the measured water quality data, the system can remotely activate the right ultrasonic program. Web-based software (MPC-View) allows users to visually track the water quality and the progress of the ultrasonic treatment.

The transmitters send ultrasonic sound waves of several specific frequencies, amplitudes, waveforms and durations into the water. The specific ultrasonic waves create a sound layer in the top layer of the water, which has a direct impact on the buoyancy of the algae. The algae cells will sink to the deeper and darker layers of the water column and are not able to photosynthesize and will eventually die due to a lack of light. However, for the efficiency of the technology it is important that specific frequency programs are used, based on the algae that require a control strategy.

Affected algae cells will sink to the bottom of the water reservoir, where they will be degraded by the bacteria present in the soil. After 3 to 4 weeks, the LG Sonic® devices control the growth of new algae from 70% to 90%.

The LG Sonic products are not based on cavitation; the LG Sonic technology uses low-power ultrasound to control algae growth. This prevents the release of algal toxins into the water.



### 4 ultrasonic transmitters for complete 360-degree algae control

- Treatment range of 500m/1600ft in diameter
- Integrated Aquawiper™, an automatic cleansing system for the ultrasonic transmitters
- Chameleon Technology™, adjusts the ultrasonic program to the specific water conditions

## 2. Water quality sensors for effective algae control

The MPC-Buoy is equipped with a set of sensors that monitor important parameters of your water quality in real time. The basic set of sensors are:

- Chlorophyll a (Algae)
- Phycocyanin (Blue-green algae)
- Dissolved Oxygen
- Turbidity
- Temperature
- pH
- Redox

\*Optional sensors are available based your needs and preferences.

These sensors can be used to provide a good overview of the concentration and type of algae present in your water reservoir. Besides that, levels of pH, temperature and turbidity can be used to predict the formation of new algal blooms and anticipate them before any problems arise. Levels of Dissolved oxygen provides you with vital information about the health of your water and condition of fish and plants within the lake.



### In-situ water quality sensors to provide real-time water quality data

- Monitors chlorophyll  $\alpha$ , phycocyanin, DO, turbidity, temperature pH, and redox
- Automatic antifouling wiper ensures optimal readings
- Optional sensors are available according to your needs and preferences

### 3. Solar panels for power supply

The MPC-Buoy is equipped with 3 solar panels of 195 Wp and 40-amp lithium batteries for autonomous power supply. The device has a power consumption of 5-20 Watts. The MPC-Buoy can provide power all year round anywhere around the world. During low battery charge, the device automatically powers off the ultrasonic transmitters. Furthermore, the device automatically switches to an energy-saving program during periods of low sun radiation.



#### Solar panels for autonomous power supply

- 3x 195 Wp high-quality solar panels that provide power, all year round in any country
- 1x 24 Volt, 40 AMP lithium battery
- Switches to energy-saving program during periods of low sun radiation
- Solar regulator



#### 4. UV- resistant buoy construction

The MPC-Buoy system consists of three unsinkable floats that carry the weight of the system. The aluminium powder coated frame is both UV and corrosion resistant. Because the construction is relatively light (250 kg), you only need a small boat to drag the device to the required installation spot, where the unit can be installed and moored.



#### Floating construction anchored to the bottom of a lake

- Aluminium powder-coated frame
- UV and corrosion resistant construction
- Unsinkable floats

## 5. Data communication for remote control

The LG Sonic data logger is designed specifically for its application in a watery environment, where monitored data needs to be continuously delivered.

The LG Sonic data logger can communicate with your office PC and is especially suitable for delivering real-time data via the internet, radio, GSM/GPRS telemetry.



### Smart communication system for remote control

- GSM/GPRS Telemetry Quadband (CDMA, Radio, GPS and Iridium Satellite optional)
- Real-time water quality data with the MPC-View software
- Integrated alarm functions

## 6. Water quality software package: MPC-View

The MPC-View software allows you to visually track the water quality in your lake or reservoir. The software receives its data from advanced water quality sensors that are integrated into the MPC-Buoy.

You can log in to the software where you will find a personal dashboard displaying an overview of your algae control projects. The software provides insight into the water quality, algae trends, and the progress of the ultrasonic treatment. Furthermore, the software displays technical parameters, such as the status of the ultrasonic transmitters, signal strength, and battery strength. This way, customers and employees of LG Sonic can remotely monitor to see whether the devices are working properly. Generated reports can be exported to Excel or converted to PDF, and from there they can be shared or published.



### MPC-View

- Dashboard with an overview of the water quality
- Set up alarms for changing water conditions and maintenance activities
- Visual insight into various parameters at a specific moment in time

Dashboard with an overview of the algae control project

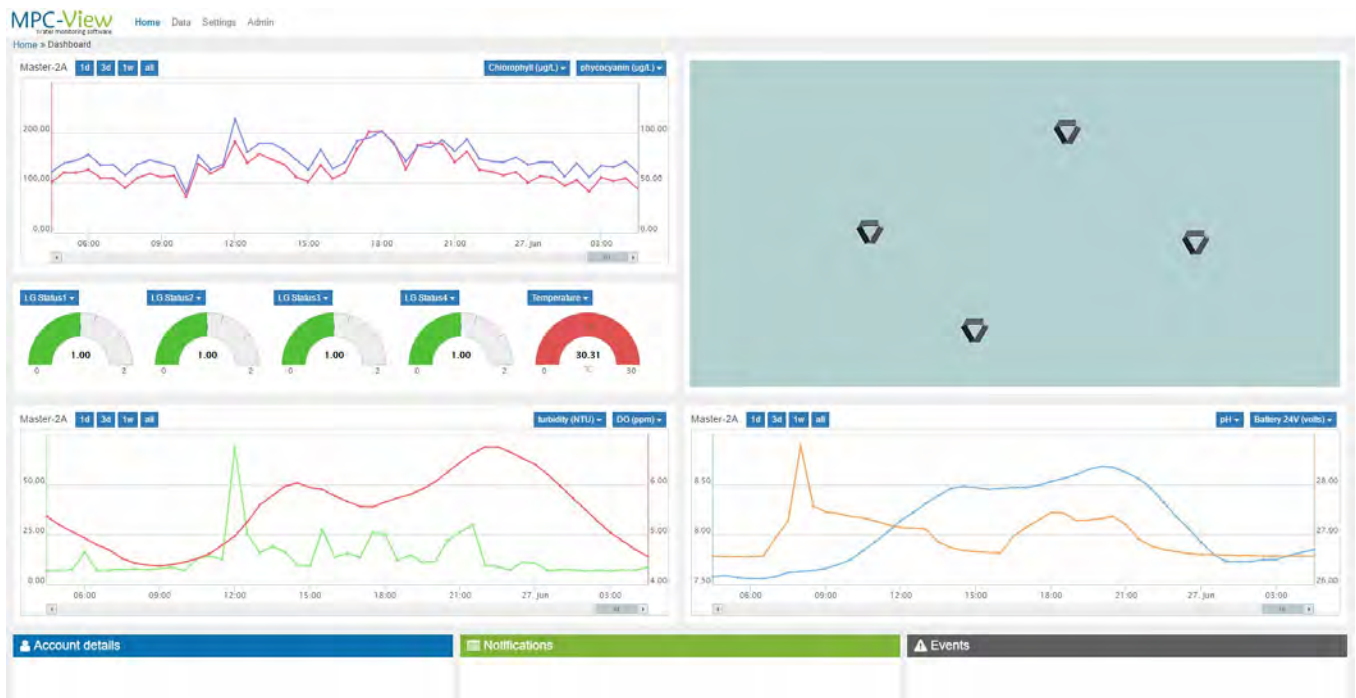

Visual insight into various parameters at a specific moment in time

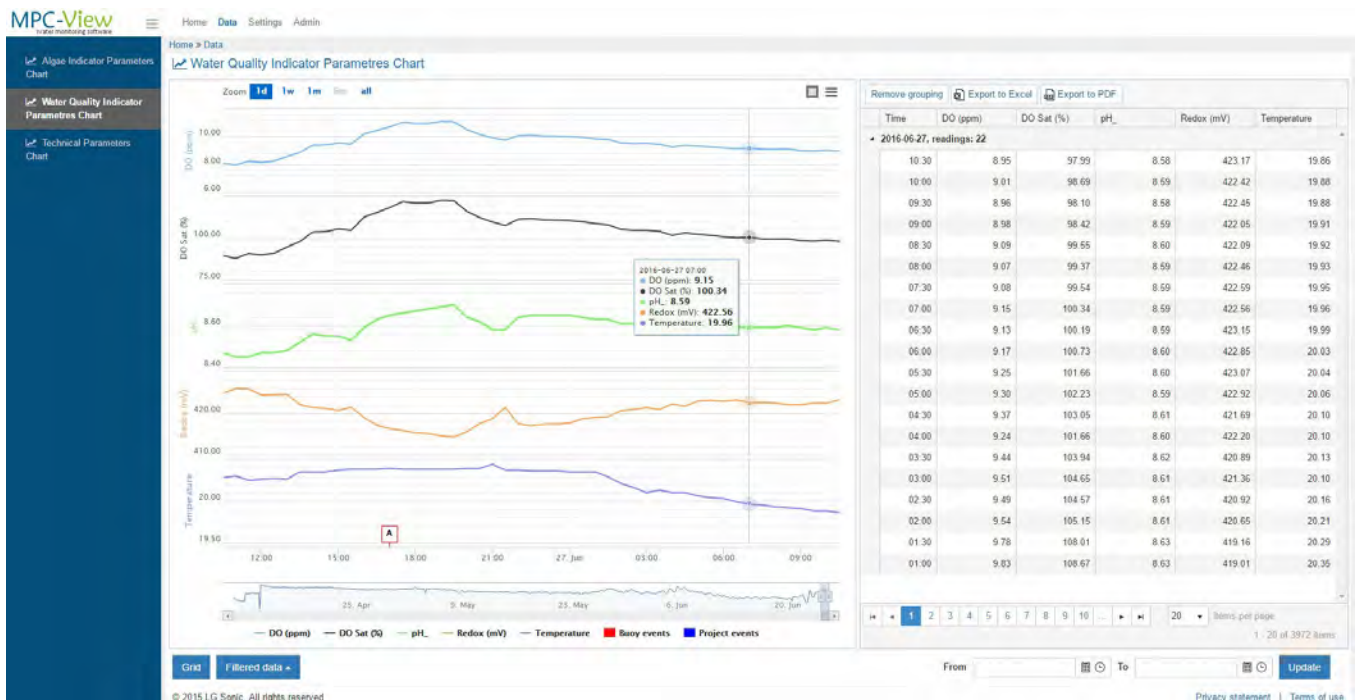

## 2.3. Technical specifications

<b>Frame</b>	<ul style="list-style-type: none"> <li>• Aluminum framed polyethylene buoy</li> <li>• Material: Rotationally-moulded UV-stabilized HDPE polyethylene</li> <li>• Filling: Closed-cell polyurethane foam</li> <li>• Buoy frame: Anodized aluminum</li> <li>• Weight: 15 kg</li> <li>• Size: 1200x600x200mm</li> <li>• Buoyancy capacity 95 kg</li> </ul>
<b>Solar panels (3x)</b>	<ul style="list-style-type: none"> <li>• Solar cell: Monocrystalline cell</li> <li>• Rated Power (Pmax): 195Wp</li> <li>• Weight: 16 kg</li> <li>• Connectors IP67</li> <li>• Size: 1580x808x35mm</li> </ul>
<b>Battery</b>	<ul style="list-style-type: none"> <li>• 1 x 24 volt lithium lifepo4</li> <li>• Capacity: 40 Ah</li> <li>• Weight: 15kg</li> </ul>
<b>Data acquisition system</b>	<ul style="list-style-type: none"> <li>• 4 x analog channel (user-configurable for either 4-20mA)</li> <li>• 1 x RS485 port for instruments</li> <li>• 1 x high frequency pulse counting channel</li> <li>• 1 SDI-12 input</li> <li>• 3X RS232</li> </ul>
<b>Telemetry</b>	<ul style="list-style-type: none"> <li>• GPRS Telemetry</li> <li>• Quadband (850/ 900 / 1800 / 1900 MHz )</li> <li>• CDMA optional</li> <li>• Radio (UHF/VHF)</li> </ul>
<b>Solar Charge Controller</b>	<ul style="list-style-type: none"> <li>• Overcharge and Deep discharge protection</li> <li>• Ip68 Protection</li> </ul>

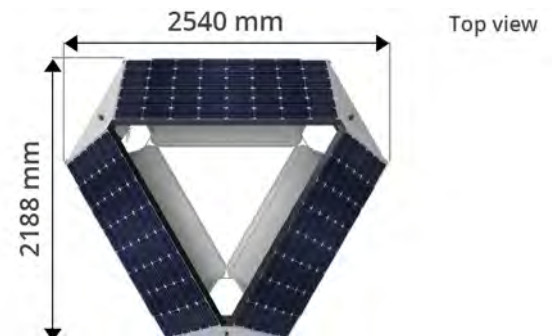

<b>Water quality sensor package</b>	
<b>Fluorescence, including anti-fouling Wiper: chlorophyll a, phycocyanin, turbidity</b> <ul style="list-style-type: none"> <li>● 470nm – Chlorophyll a</li> <li>● 610nm – Phycocyanin</li> <li>● 685nm Turbidity</li> </ul>	<b>Redox</b> <ul style="list-style-type: none"> <li>● Combined electrode</li> <li>● (Redox/reference):</li> <li>● Platinum tip, Ag/AgCl</li> <li>● AgAgCl.</li> <li>● Gelled reference (KCl)</li> <li>● Range - 1000 to + 1000 mV</li> <li>● Resolution 0,1 mV</li> <li>● Accuracy <math>\pm</math> 2 mV</li> </ul>
<b>pH</b> <ul style="list-style-type: none"> <li>● Combined electrode</li> <li>● (pH/ref):</li> <li>● special glass, Ag/AgCl ref.</li> <li>● Gelled electrolyte (KCl)</li> <li>● Range 0 – 14 pH</li> <li>● Resolution 0,01 pH</li> <li>● Accuracy +/- 0,1 pH</li> </ul>	<b>Temperature</b> <ul style="list-style-type: none"> <li>● Technology CTN</li> <li>● Range 0.00 °C à + 50.00°C</li> <li>● Resolution 0,01 °C</li> <li>● Accuracy <math>\pm</math> 0,5 °C</li> <li>● Response time &lt; 5 s</li> </ul>
<b>Dissolved Oxygen</b> <ul style="list-style-type: none"> <li>● Optical measure by</li> <li>● luminescence</li> <li>● Measure ranges:</li> <li>● 0.00 to 20.00 mg/L</li> <li>● 0.00 to 20.00 ppm</li> <li>● 0-200%</li> </ul>	

## 3. Delivery and guarantee

### 3.1. Delivery method

Sea cargo/airfreight/road

Method of shipment: Delivery at Place (DAP)

#### Delivery time

The products will be shipped within 6 weeks after receiving payment. Shipping time depends on shipping method: 1 and 3 weeks

### 3.2. Guarantee

LG Sonic BV, the producer, has great confidence in its products and guarantees the quality of assembly and materials used. The warranty is limited to materials and faulty construction and covers terms of ONE, TWO, THREE or FIVE YEARS after purchase date for different parts of the MPC-Buoy.

The system specifications and the assigned years of guarantee coverage are listed in the table below:

System element	Includes	Years of guarantee
Ultrasonic system	<ul style="list-style-type: none"> <li>Up to 4 LG Sonic e-line XXL transmitters connected to one control box</li> <li>Treatment range of 500 meter in diameter</li> <li>Ultrasonic treatment coverage of 360°</li> </ul>	3
Water quality sensor package	Water quality sensors: pH, dissolved oxygen, temperature, redox, turbidity, chlorophyll a, phycocyanin.	1
Solar system	<ul style="list-style-type: none"> <li>3x 195 WP solar panels</li> <li>2x 12 Volt, 40 AMP lithium batteries</li> <li>Solar regulator</li> </ul>	5 1 2
Buoy construction	<ul style="list-style-type: none"> <li>Aluminum-framed polyethylene buoy</li> <li>Stainless steel construction for solar panel mount</li> <li>HDPE enclosure for electronic box and batteries</li> </ul>	3

## 4. LG Sonic company profile

### Algae control solutions

LG Sonic is a Dutch, privately owned company with the mission to eliminate harmful chemicals in the environment. Therefore, the company developed a chemical-free technology that controls algae without disturbing the natural balance within water ecosystems. LG Sonic works together with different European Universities and Research institutes, many of which are European funded research and development projects.



### Value proposition

Algae cause problems when blooming in lakes and water reservoirs such as damage to filters/ pumps and losses in recreation use. Solutions such as copper-sulfate are besides costly, labor intensive also harmful for the ecosystem. In order to provide an environmentally friendly and cost-effective solution to these problems, LG Sonic developed the MPC-Buoy, a floating, solar powered, platform that combines continuous online water quality monitoring, web-based software, and ultrasonic technology to effectively control harmful algal blooms in large water surfaces, such as lakes and water reservoirs. The MPC-Buoy eliminates up to 90% of the existing algae and prevents the growth of new algae. Furthermore, the MPC-Buoy allows to reduce TSS, BOD and chemical consumption.

### Track record

- Coordinator of several European FP7 projects: ClearWater PMPC and Dronic (€3.2 million)
- Official Innovation Partner of American Water, U.S. largest water and waste water utility
- Winner of several innovation award such as the Aquatech Innovation Award (2015)
- Winner of several entrepreneur awards such as the Shell LiveWIRE Award (2014)







Medora Corporation  
**GridBee<sup>®</sup> SolarBee<sup>®</sup>**

Main Office & Service Center  
1-866-437-8076 | medoraco.com  
3225 Highway 22, Dickinson, ND 58601

## **Budget Estimate: Reservoir Circulation Equipment for the Green Ridge Glade Reservoir**

**Date:** December 12, 2016

**Project #:** 6176

**To:** Eli B. Townsend

Corona Environmental Consulting, LLC

Cell: (248) 804-0264

etownsend@coronaenv.com

**From:** Dave Summerfield, Medora Corporation Regional Manager, Denver, CO

dave.s@medoraco.com • 951-265-2321

Harvey Hibl, Medora Corporation West U.S. Manager, Westminster, CO

harvey.hibl@medoraco.com • 303-469-4001

Darren Tessier, Medora Corporation Sales Engineering Dept., Dickinson, ND

darren.t@medoraco.com • 866-437-8076

Mr. Townsend,

Thank you for requesting this reservoir evaluation and budget estimate. We are very pleased to work with Corona Environmental Consulting and the City of Loveland Water and Power to provide high-quality raw water circulation equipment for the Green Ridge Glade Reservoir (GRGR). This project fits our capabilities well, and we will do everything possible to ensure your project flows smoothly and meets Loveland's goals and expectations. Please contact us with any questions.

Best regards,

*Darren Tessier*

Medora Corporation

# PROJECT DESCRIPTION

## 1. Name and Location of Reservoir

Green Ridge Glade Reservoir - Loveland, CO (GPS Coordinates 40.441986°, -105.216012°)

## 2. Description of Reservoir:

GRGR is a 150-acre drinking water reservoir with an average depth of 42 feet and a maximum depth of 78 feet. There is one source of inflow to the reservoir, the Charles Hansen Feeder Canal. Every year, GRGR is plagued by taste and odor problems, ranging from minor in the spring to severe in the fall, due to cyanobacteria, specifically the Anabaena strain of blue-green algae.

GRGR has a manganese issue as well (Mn levels up to 500 ug/L). Flows to the WTP are shown below:

- The maximum daily draw from the reservoir is 28 MG.
- The average daily draw from the reservoir is 9.8 MG.
- The minimum daily flow from the reservoir is 0.02 MG.

The City currently uses an intake gate that is 59.1 feet below the surface. Another gate that is 42 feet below the surface was used in the past, and may again in the future.

## 3. Customer Objectives

To provide long-distance solar-powered circulation in order to control harmful cyanobacteria (blue-green algae) blooms, to reduce taste and odor issues, and to improve overall water quality.

In addition, to provide deeper circulation in order to improve dissolved oxygen levels to reduce manganese (Mn) levels.

## 4. Medora Corporation Recommendation/System Design for this Project

To meet the above objectives, we recommend the installation of between 10 (ten) SolarBee model SB10000LS v20 reservoir circulators, four set for epilimnetic circulation to combat cyanobacteria, spaced evenly in the reservoir (see aerial placement photo in Section 5 below), and six set for hypolimnetic circulation for Mn.

Pricing Note: Pricing difference between epilimnetic and hypolimnetic machines shown below reflects the added equipment needed in the deeper water hypolimnetic application. (Reconditioned units are available at a lower cost for both applications, and come with an as-new warranty.)

Epilimnetic Circulation will prevent surface water stagnation and associated harmful blue-green algae blooms, and in turn reduce the amount of algal biomass (and biochemical oxygen demand) going to the bottom. By controlling algal blooms and enhancing the distribution of dissolved oxygen in the water column, the lake will be healthier with improved water clarity and significantly reduced odors.

Hypolimnetic Circulation will provide an oxygenated water column above the SolarBee fluid intake setting depth, which is below the lowest intake gate to the treatment plant being used, in order to prevent soluble manganese (Mn) and iron (Fe) released from the sediments from accumulating in this water column.

**Cyanobacteria Management Plan (CMP)**: The US EPA produced a paper in June 2015 to help cities and other organizations develop a CMP for lakes. This paper states that surface mechanical mixing equipment (such as SolarBee lake circulators), has been used in U.S. water bodies for controlling cyanobacteria (i.e., blue-green algae). "This mixing of the water column disrupts the cyanobacteria migration and limits availability of nutrients." (U.S. EPA, 2014d)

To read the full paper, it can be downloaded at this link:

<http://www2.epa.gov/nutrient-policy-data/recommendations-public-water-systems-manage-cyanotoxins-drinking-water>

## 5. Proposed Machine Locations:

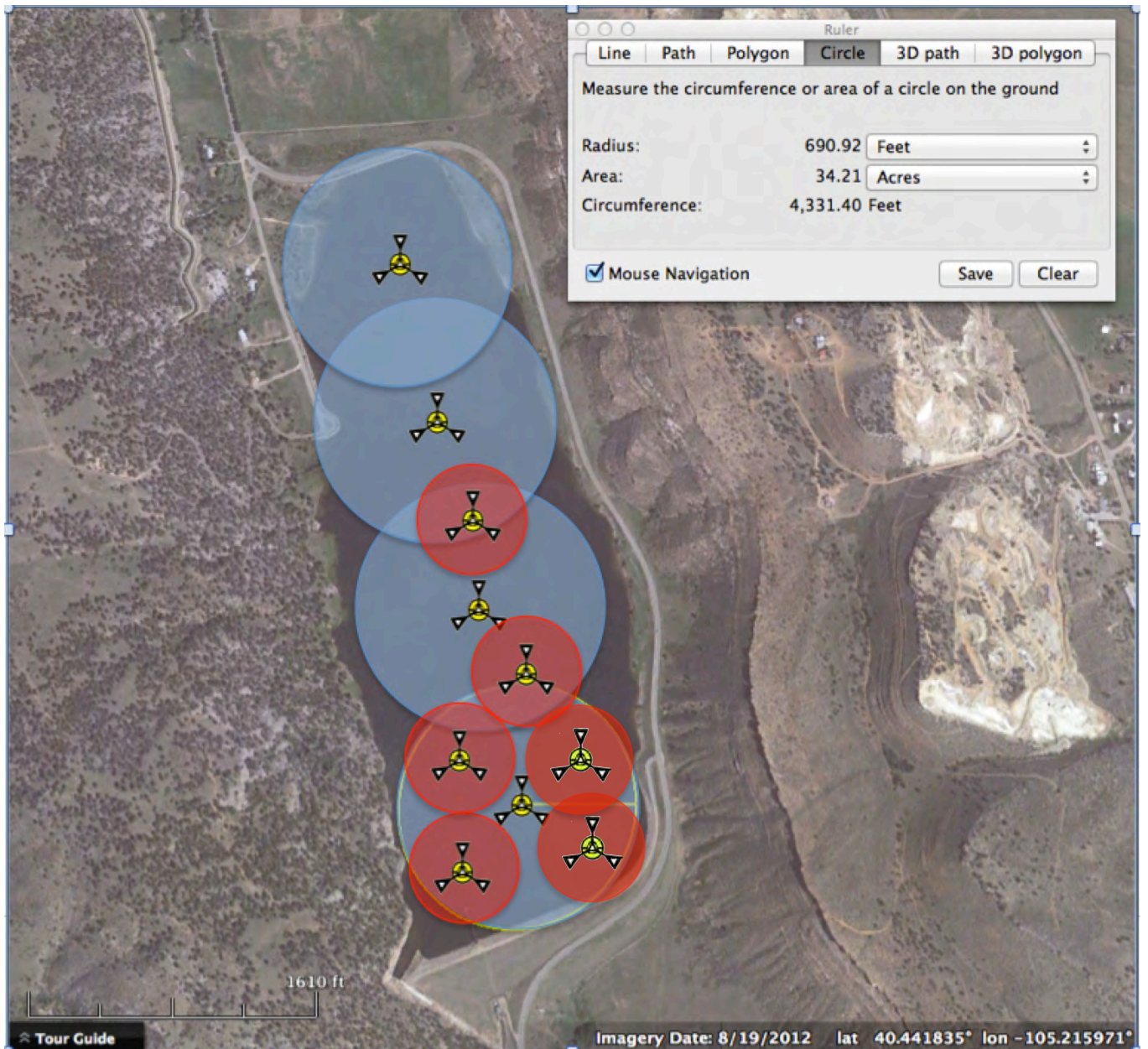

The SolarBees are not drawn to scale; final placement will be determined prior to machine deployment; the blue area circles represent epilimnetic circulation and are scaled to approximately 35 acres. The red area circles represent hypolimnetic circulation; for contrast only, not too scale.

# PRICING

## 6. Equipment Cost - For Equipment Details, See Attached Documents

### Pricing for Epilimnetic Machines:

Quantity	Equipment Description	Cost Each	Equipment Total
4	SB10000LS v20 SolarBee Circulators (epilimnetic):	\$44,815	\$179,260
Equipment Subtotal:			\$179,260
Applicable Taxes:			- to be determined -
4	Factory Delivery, Placement, and Startup:	\$5,500	\$22,000
Discount for 4 machines delivered and placed in one trip:			\$4,400
Discounted Factory Delivery, Placement, and Startup:			\$17,600
<b>Equipment, Factory Delivery, Placement, and Startup*:</b>			<b>\$196,860</b>

\* For Reconditioned Machines, Total Cost = \$165,150

12-Month Rental (See General Provisions for Details)		
Monthly cost for recommended machine(s) per above:	\$4,125	
Monthly Beekeeper cost during the term of the rental:	\$560	
*Factory Delivery, Placement, and Startup:	\$17,600	
<b>Total 12-Month Rental Cost:</b>		<b>\$73,820</b>

\*When the rental period is over, if the City does not wish to purchase or continue the rental and has paid the placement cost, then Medora pays the retrieval cost.

### Pricing for Hypolimnetic Machines at Flow to WTP of 28 MGD:

Quantity	Equipment Description	Cost Each	Equipment Total
3	SB10000LS v20 SolarBee Circulators (hypolimnetic):	\$52,015	\$156,045
Equipment Subtotal:			\$156,045
Applicable Taxes:			- to be determined -
3	Factory Delivery, Placement, and Startup:	\$5,500	\$16,500
Discount for 3 machines delivered and placed in one trip:			\$2,475
Discounted Factory Delivery, Placement, and Startup:			\$14,025
<b>Equipment, Factory Delivery, Placement, and Startup*:</b>			<b>\$170,070</b>

\* For Reconditioned Machines, Total Cost = \$146,370

12-Month Rental (See General Provisions for Details)	
Monthly cost for recommended machine(s) per above:	\$3,590
Monthly Beekeeper cost during the term of the rental:	\$420
*Factory Delivery, Placement, and Startup:	\$14,025
<b>Total 12-Month Rental Cost:</b>	<b>\$62,145</b>

\*When the rental period is over, if the City does not wish to purchase or continue the rental and has paid the placement cost, then Medora pays the retrieval cost.

**Pricing for Hypolimnetic Machines at Average Daily Flow to WTP of 9.8 MGD:**

Quantity	Equipment Description	Cost Each	Equipment Total
6	SB10000LS v20 SolarBee Circulators (hypolimnetic):	\$52,015	\$312,090
Equipment Subtotal:			\$312,090
Applicable Taxes:			- to be determined -
6	Factory Delivery, Placement, and Startup:	\$5,500	\$33,000
Discount for 6 machines delivered and placed in one trip:			<b>\$9,900</b>
Discounted Factory Delivery, Placement, and Startup:			\$23,100
<b>Equipment, Factory Delivery, Placement, and Startup:</b>			<b>\$335,190</b>

\* For Reconditioned Machines, Total Cost = \$287,700

12-Month Rental (See General Provisions for Details)	
Monthly cost for recommended machine(s) per above:	\$8,175
Monthly Beekeeper cost during the term of the rental:	\$840
*Factory Delivery, Placement, and Startup:	\$23,100
<b>Total 12-Month Rental Cost:</b>	<b>\$131,280</b>

\*When the rental period is over, if the City does not wish to purchase or continue the rental and has paid the placement cost, then Medora pays the retrieval cost.

Options for Solar Models		
SB Series SCADA	<i>All SB v20 and reconditioned v18 models come standard with a SCADA brain-board with six outputs. (For on-site communication options, please contact our SCADA Engineering Department.)</i>	Please request option list

Beekeeper Service Program	The details of the Beekeeper Service Program are available at: <a href="https://www.medoraco.com/beekeeper">https://www.medoraco.com/beekeeper</a> .	Call for pricing
---------------------------	---	------------------

## TERMS

### 7. General Provisions

**A. Material Supplier only.** This budget estimate is to supply materials only. No contracting or construction work of any type is being offered or will be performed by Medora Corporation (Medora) at the jobsite or at any Medora location or factory.

1) To order the materials in this quotation, the purchaser should use the same type of purchase order as would be used to order other materials; for example, a desk or a forklift. Please do not attempt to order the equipment quoted here with a "contractor" or "subcontractor" agreement of any sort, because Medora is strictly a material supplier, not a contractor, and would have to reject that type of agreement.

2) The US Department of Labor clearly defines a Material Supplier, such as Medora, and its allowable activities. All activities by Medora factory personnel to transport, place and start up the Medora equipment are incidental to Medora being a Material Supplier, and Medora will not perform contracting or construction work of any type for any project. Also, no local, state, or federal laws regarding contractors or construction projects, or Davis Bacon or similar reporting requirements, are applicable to this quotation because Medora is not a contractor and does not perform any construction activities.

3) It is the responsibility of the purchaser of Medora's equipment to determine in advance whether there are any contracting or construction activities required in order for Medora's equipment to be made operational. Usually there aren't any such activities; but if there are, it is the purchaser's sole responsibility, at its sole cost, to perform all of those activities in advance of Medora's equipment arriving at the jobsite.

**B. Assumptions:** This budget estimate may be based on worksheets, calculations or other information that has been provided by the City. The City should bring to Medora's attention any discrepancies, errors in data, or false assumption that Medora may have made while preparing this quotation.

**C. Expiration:** This budget estimate expires in 90 days, or on the date of any new quotation for this project, whichever is sooner.

**D. Delivery Time:** Delivery, Placement, and Startup is scheduled at time of order, and is usually between 4 and 8

**E. Payment Terms:** For a federal, state, or local government purchaser with a good credit rating, full payment is due in US dollars 30 days after invoice date, which is generally the date when the goods leave the Medora factory. For a non-government purchaser, full payment must be made by credit card or cashier's check before the goods leave the Medora factory though, in some cases, based on availability of a payment bonding or a bank Letter of Credit, 30 day credit terms may be extended upon special request by the purchaser. If there are any issues with these payment terms, please do not rely on this quotation until the issues have been resolved with Medora.

**F. Add for Taxes and Any Governmental Fees:** Except as indicated above, no taxes, tariffs or other governmental fees are included in the quote shown above, nor are there any costs added for special insurance coverage the customer may require. It is the customer's responsibility to pay all local, state, and federal taxes, including, sales and use taxes, business privilege taxes, and fees of all types relating to this sale, whether they are imposed on either Medora or the customer, or whether these taxes and fees are learned about after the customer orders the equipment. The customer's purchase order should indicate any taxes or fees due on equipment and/or services, and whether the customer will pay them directly to the governing body or include the tax payment with the purchase for Medora to submit them to the governing body.

**G. Add for Special Insurance Requirements:** Medora Corporation maintains adequate liability and workman's compensation insurance to generally comply with its requirements for doing business in all fifty U.S. states, and will provide at no charge certificates of insurance when requested. However, if additional insurance or endorsements beyond the company's standard policy are required by the customer, then the costs of those additional provisions and/or endorsements will be invoiced to the customer after the costs become known.

**H. Add for Special Training, Safety, Signage, or Other Requirements:** Medora has a very strong safety training program for its employees. If any special training classes for Medora personnel are required by the customer, please notify Medora well in advance. The cost of this training will be added to this quotation or invoiced to the customer separately. The same applies to any other special requirements the customer may have, including providing of project signage or any other requirement.

**I. Safe and Accessible Working Conditions Required.** This quotation is based on the best information made available to us by the above date. If this equipment is ordered, Medora's engineering and installation team will need detailed information and photographs to plan the installation. If the detail information changes the installation scope significantly, Medora reserves the right to withdraw or alter this quotation, even if the equipment has already been ordered. To avoid surprises, the City should supply detailed information and photos as soon as possible to ensure the safety of Medora's installation crews.

**J. Customer to Follow Medora's Maintenance and Safety Guidelines:** The customer agrees to follow proper maintenance, operating, and safety instructions regarding the equipment as contained in the safety manual that accompanies the equipment or is sent to the customer's address.

**K. Regulatory Compliance.** The customer must comply with all applicable Federal and State governmental regulations. It is the customer's sole responsibility to inquire about governmental regulations and ensure that GridBee and SolarBee equipment is deployed and maintained so as to remain in compliance with these regulations and guidelines, and to hold Medora harmless from any liability caused by non-compliance with these regulations and guidelines.

**L. Warranty.** Medora Corporation has the best parts and labor warranties that we are aware of in the industry. The details of the Warranty which applies to this project are either attached to this document or are available at:

<https://www.medoraco.com/resources/warranty-information>.



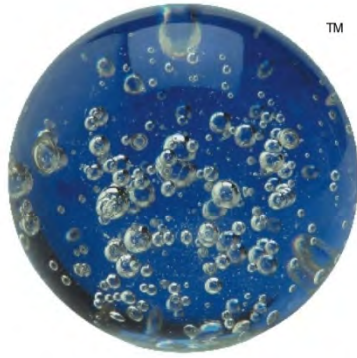

**ECO<sub>2</sub>**<sup>®</sup>

**Hypolimnetic Oxygenation System  
For Water Quality Improvements at  
Green Ridge Glade Reservoir**

**City of Loveland, CO**



**December 13, 2016**



December 13, 2016

Eli B. Townsend  
Corona Environmental Consulting, LLC  
[etownsend@coronaenv.com](mailto:etownsend@coronaenv.com)  
303.544.2161

**Re: ECO<sub>2</sub> Green Ridge Glade Hypolimnetic Oxygenation System**

Dear Eli,

Thank you for your interest in an ECO<sub>2</sub> SuperOxygenation System to oxygenate the hypolimnetic layer of Loch Lomond. Raising the D.O. in the hypolimnion of the reservoir to maintain aerobic conditions above the sediment minimizes the internal nutrient load in a lake, which has a direct effect on eutrophication and water quality.

The ECO<sub>2</sub> SuperOxygenation System is a very effective oxygen transfer device with a proven average oxygen transfer efficiency of 95%. A high oxygen transfer efficiency translates directly into savings in oxygen supply costs. With an ECO<sub>2</sub> SuperOxygenation System dissolved oxygen is delivered in a liquid stream horizontally above the sediment where oxygen is needed most.

ECO<sub>2</sub> has several successful installations across the country adding dissolved oxygen to the hypolimnion of lakes and reservoirs to prevent sulfide formation and improve water quality by minimizing iron, manganese and phosphorous release. The high oxygen transfer efficiency and low maintenance and operating costs make the ECO<sub>2</sub> System the technology of choice for efficient oxygen addition to lakes and reservoirs.



Based on the oxygen requirements of 1,800lbs/day, ECO<sub>2</sub> has designed a Hypolimnetic Oxygenation System for the Green Ridge Glade Reservoir. The system can be either installed on shore or submerged at the bottom of the lake. An on-shore installation is easier, but the system has to be pressurized to add the required amount of oxygen, increasing the HP on the sidestream pump. The system will have to be installed by a local contractor. ECO<sub>2</sub> will be available to provide support for the design team completing the on-site design.

Please find a description of the proposed system below and let us know if you have any questions. We look forward to working with you on this project.

Best regards,

*Inken Mello*

Inken Mello  
Director of Sales & Marketing  
**Eco Oxygen Technologies, LLC**  
Phone: 858-272-7102  
e-mail: [imello@eco2tech.com](mailto:imello@eco2tech.com)

*NOTES: This proposal contains information that is considered proprietary to ECO Oxygen Technologies, LLC (ECO<sub>2</sub>). Disclosure of its content to another party other than the party it is addressed to is strictly prohibited without ECO<sub>2</sub>'s written authorization.*



## I. ECO<sub>2</sub> SYSTEM DESCRIPTION

The ECO<sub>2</sub> SuperOxygenation Technology is based on Henry's Law and works by trapping pure oxygen bubbles inside the ECO<sub>2</sub> cone until they are dissolved. The system operates by pumping a side stream of water through a conical shaped oxygen transfer reactor, also known as the Speece Cone. Gaseous oxygen is fed into the cone and broken up into an intense bubble swarm by the velocity of the wastewater. This action creates an exceptionally large oxygen / water interface. The cone shape design provides sufficient contact time for the oxygen to fully dissolve in the water. The cone achieves an oxygen transfer efficiency of >90%.

The ECO<sub>2</sub> SuperOxygenation system can be installed in a small footprint on shore or can be submerged in the reservoir.

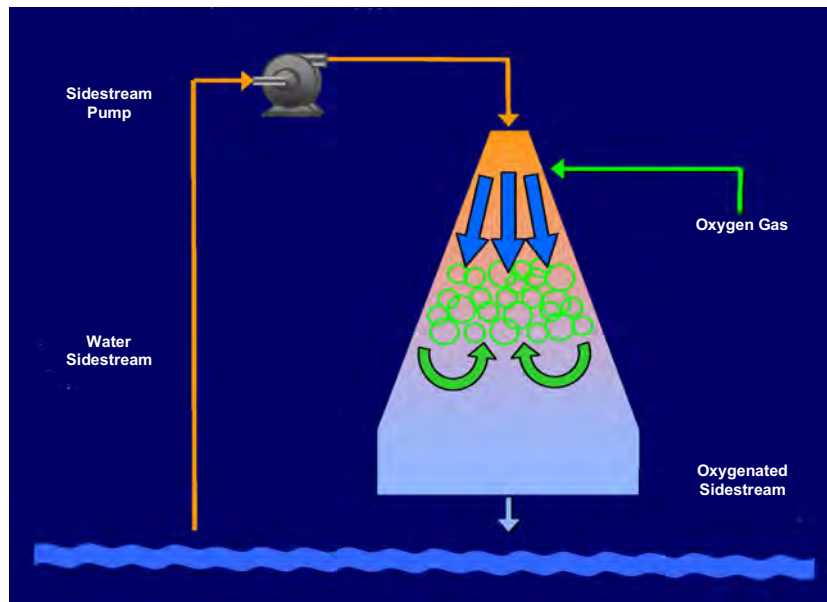

Each ECO<sub>2</sub> System consists of a pressure-rated, hollow, stainless steel cone with no internal mixers, baffles or moving parts. The influent and effluent pipes employ wide openings to prevent clogging. The dish-shaped bottom with the discharge pipe at the low point provides for a self-cleaning device with no need for maintenance.

**The ECO<sub>2</sub> System has a life expectancy of 20+ years.** The oxygen feed is fully automated. The only moving part is the side stream pump that requires standard maintenance.



## II. ECO<sub>2</sub> BASIS OF DESIGN

The system is designed around an assumed hypolimnetic oxygen uptake rate of 0.25mg/L/day in a 860MG hypolimnion for a total required oxygen uptake of 1,793 lbs/day.

The system will be installed on land near the dam and draw water from the deepest area of the reservoir into the cone, oxygenate it and send the oxygenated water back into the reservoir horizontally across the sediment. The system will be pressurized to raise the DO to the required level.

## III. ECO<sub>2</sub> SYSTEM DESIGN

To add 1,800 lbs/day of oxygen to the Green Ridge Glade Reservoir with an on-shore installation, the following ECO<sub>2</sub> System is required:

<b>ECO<sub>2</sub> System Design</b>	<b>On-Shore Installation</b>
System Size (dia.)	6 ft
System Height (ft)	15 ft
Sidestream Flow (gpm)	2,800 gpm
Sidestream HP	54 HP
Discharge D.O. (mg/L)	63 mg/L
O <sub>2</sub> Dissolution Capacity (lbs/day)	1,950 lbs/day



#### IV. ECO<sub>2</sub> PROPOSAL

The proposed system is equipped with simple oxygen flow controls that can be dialed in to add a manually set amount of oxygen to the lake. A sidestream pump is required to run a continuous sidestream through the system. Oxygen can be delivered to the site by Praxair.

	<b>On-Shore Installation</b>
ECO <sub>2</sub> System	\$230,000
Simple Oxygen Flow Controls	Incl.
Sidestream Pump (Estimate)	\$60,000
Shipping	\$4,000
<b>Total Capital Cost</b>	<b>\$294,000</b>

Prices do not include sales taxes.

Payment Terms are 30% upon approval of submittals, 60% upon delivery and 10% upon start-up.



## V. ECO<sub>2</sub> GUARANTEE

### Experience

ECO<sub>2</sub> SuperOxygenation Systems (aka Speece Cone) for water and wastewater treatment are designed and produced by ECO Oxygen Technologies, LLC (ECO<sub>2</sub>), an independent company founded in 2001 and headquartered in Indianapolis, Indiana. The technology is the pioneering effort of Dr. Richard Speece, Centennial Professor Emeritus of Civil and Environmental Engineering at Vanderbilt University, who invented the "Speece Cone". ECO<sub>2</sub> has teamed with Dr. Speece to develop the next generation of oxygen dissolving technology and holds several patents around the Speece Cone. ECO<sub>2</sub> is the end supplier of these systems and is wholly responsible for the design, fabrication, installation oversight, and startup and training. ECO<sub>2</sub> Speece Cone systems have been developed using specific engineering know-how, trade secrets and project experience and operating history.

ECO<sub>2</sub> has over 10 years of experience in the design, assembly, start-up and operation of SuperOxygenation systems. The oldest ECO<sub>2</sub> SuperOxygenation Systems have been installed in lakes in the 1990s and are still in operation to date.

ECO<sub>2</sub> has over 50 systems installed throughout the US. All systems run continuously and reliably with a minimum amount of maintenance required. ECO<sub>2</sub> stands behind superior quality and guarantees each system to perform at a minimum of 90% oxygen transfer efficiency.

### The ECO<sub>2</sub> Approach to Successful Installations

ECO<sub>2</sub> working in partnership with Dr. Speece has spent over a decade developing, perfecting and implementing Speece Cones throughout the United States and internationally.

Teaming with Dr. Speece, ECO<sub>2</sub> has gained invaluable firsthand experience and engineering know how to understand and master the interworking nuances required to be able to successfully design, fabricate and implement Speece Cone systems.

In addition to being proficient in Speece Cone design, ECO<sub>2</sub> has gained significant experience and knowledge in ancillary equipment necessary for a fully functional Speece Cone system. This



includes expertise in correctly specifying and sizing the side stream pump, oxygen supply, piping arrangements, civil and electrical works. ECO<sub>2</sub> knows how to operate and service the Speece Cone in multiple applications and system configurations.

### **ECO<sub>2</sub> Performance Guarantee**

ECO<sub>2</sub> will guarantee an oxygen transfer efficiency (OTE) of a minimum of 90% in the cone. ECO<sub>2</sub> Systems have a proven track record of an average oxygen transfer efficiency of 95%. These transfer efficiencies have been measured on multiple systems in various applications ranging from clean water to raw wastewater.





January 05, 2017

Quote: MMP010517886

Amlan Ghosh  
Corona Environmental  
Project: Loveland, CO

Amlan,

Thank you for your interest in Calgon Carbon Corporation to complete your upcoming GAC installation. We are pleased to offer our services to assist you in this endeavor.

The budgetary price for performing the GAC installation of 160,000 pounds of Filtrasorb 820 virgin activated carbon is \$264,000 or \$1.65 / lb. This price is all inclusive for capping 11.5" on the 20 gravity filters at the Loveland, CO WTP, and is subject to Calgon Carbon Corporation's standard terms and conditions, a copy of which is attached. Calgon Carbon Corporation is proposing to perform the GAC installation using slurry via education techniques.

As a reminder for slurry service, the following conditions should be met -- Compressed air (100 cfm min.), water (60 psig and 150 gpm min.), drainage, 110V, 20 A power, lighting, and restrooms readily available.; Additional cost over-runs will be invoiced for wait time, poor equipment access, difficult to remove or install media, excessive trailer drain times, or other variances from the standard scope of supply.

This quote does not include any applicable taxes. Standard lead time is 15 – 20 business days after receipt of a purchase order.

***Quote is strictly budgetary and valid for 120 days.  
Pricing beyond the terms stated above is subject to change.***

*Subject to Calgon Carbon Corporation Terms and Conditions.*

Please feel free to contact me with any additional questions.

Sincerely,

Mark W. Peet  
Senior Technical Sales Representative  
Calgon Carbon Corporation

## ***Proposal Validity and Scope***

### **Proposal Validity**

Quotation is strictly budgetary and valid for 120 days. Sales/Use Taxes ARE NOT included. Payment terms are net 30 days from date of invoice. Unless otherwise noted in Calgon Carbon's Sales Proposal or Customer's Purchase Order, the services to be provided by Calgon Carbon and the requirements of the customer are defined in the following sections. Additional service costs will be invoiced for wait time, poor equipment access, difficult to remove or install media, excessive trailer drain times, or other variances from the standard scope of supply.

### **Standard Scope of Supply**

Our quoted service price includes slurry placement of 11.5" of F820 on 20 existing gravity filters. Service is performed during normal operating hours of Monday to Friday. Weekend and holiday work can be performed at special rates. Bulk exchange pricing assumes adequate access to the vessel, customer supplies air and water for the exchanges, and vessel is equipped with media discharge and media fill lines terminated with male Camlock-type fittings. Two (2) hours are allotted for water to drain from trailers. Vacuum vessel change-out pricing assumes vertical cylindrical vessels with top entry that can be filled pneumatically by pulling a vacuum on the vessel or by drop loading from super sacks directly over the top man-way. To avoid additional invoiced costs, conditions defined in the Site Criteria, Additional Criteria for Vacuum Service, and Spent Media Disposal sections below must also be met.

### **Site Criteria:**

1. Compressed air (100 cfm min.), water (60 psig and 150 gpm min.), drainage, 110V, 20 A power, lighting, and restrooms readily available.
2. Suitable access and staging areas for materials and service equipment within 100 feet of equipment to be serviced.
3. Spent media must be free flowing and of a nature (e.g. not gummy or attrited) that does not blind water separation nozzles or screens.
4. Customer is to open all man ways for inspections, vacuum service and dry fills. Failure to allow Calgon Carbon to internally inspect the vessel for damage to under-drains that might result in a carbon release and for a spent carbon heel in the vessel that may cause premature contaminate break-through will make these failures solely the responsibility of the customer.
5. At sites where spent media is classified as a RCRA hazardous waste, customer is responsible for the disposal of contaminated PPE, equipment (e.g., filters) and decontamination rinse water.
6. Inclement weather provisions:
  - For extreme weather conditions (temp < 30 F or > 90 F; wind > 15 mph; heavy rain or snow, etc.), work may be postponed for safety reasons. However, in emergency situations, exceptional provisions (e.g. portable heaters, tarps, etc.) may be used to complete the work. Costs of such provisions are the responsibility of the customer.
  - Impassable roadways at a site will be considered a safety hazard and will result in delay or cancellation charges.

**Cost Over-Runs**

Pricing is based on indicated quantities of media. If removed or replaced quantity is greater, the invoice will reflect actual quantity and additional costs for transportation, field service crew and material. If repairs to a vessel are required, labor and charges for additional materials and equipment will be invoiced as cost over-runs. Additional cost over-runs will be invoiced for wait time, poor equipment access, difficult to remove or install media, excessive trailer drain times, or other variances from the standard scope of supply. If media is solidified and customer requests Calgon Carbon to remove media, Calgon Carbon will not assume responsibility for any damage to vessel interior.